

**WALCHEM**

An Iwaki America Company

WDIS410 Disinfection Controller

# WDIS410 Series Disinfection Controller Instruction Manual

Five Boynton Road Hopping Brook Park Holliston, MA 01746 USA

TEL: 508-429-1110 FAX: 508-429-7433 WEB: [www.walchem.com](http://www.walchem.com)

## **Notice**

© 2009 WALCHEM, An Iwaki America Incorporated Company (hereinafter "Walchem")  
Five Boynton Road, Holliston, MA 01746 USA  
(508) 429-1110  
All Rights Reserved  
Printed in USA

## **Proprietary Material**

*The information and descriptions contained herein are the property of WALCHEM. Such information and descriptions may not be copied or reproduced by any means, or disseminated or distributed without the express prior written permission of WALCHEM, Five Boynton Road, Holliston, MA 01746.*

## **Statement of Limited Warranty**

*WALCHEM warrants equipment of its manufacture, and bearing its identification to be free from defects in workmanship and material for a period of 24 months for electronics and 12 months for mechanical parts and electrodes from date of delivery from the factory or authorized distributor under normal use and service and otherwise when such equipment is used in accordance with instructions furnished by WALCHEM and for the purposes disclosed in writing at the time of purchase, if any. WALCHEM's liability under this warranty shall be limited to replacement or repair, F.O.B. Holliston, MA U.S.A. of any defective equipment or part which, having been returned to WALCHEM, transportation charges prepaid, has been inspected and determined by WALCHEM to be defective. Replacement elastomeric parts and glass components are expendable and are not covered by any warranty.*

*THIS WARRANTY IS IN LIEU OF ANY OTHER WARRANTY, EITHER EXPRESS OR IMPLIED, AS TO DESCRIPTION, QUALITY, MERCHANTABILITY, and FITNESS FOR ANY PARTICULAR PURPOSE OR USE, OR ANY OTHER MATTER.*

180367.D  
Jan 2009

# TABLE OF CONTENTS

1.0	INTRODUCTION.....	1
2.0	SPECIFICATIONS .....	2
2.1	Sensors .....	2
2.2	Electrical: Input/Output .....	2
2.3	Mechanical (Controller).....	3
2.4	WDIS Variables and their Limits .....	3
3.0	UNPACKING & INSTALLATION.....	4
3.1	Unpacking the unit .....	4
3.2	Mounting the electronic enclosure .....	4
3.3	Installation.....	4
3.4	Icon Definitions .....	6
3.5	Electrical installation .....	9
4.0	FUNCTION OVERVIEW .....	12
4.1	Front Panel .....	12
4.2	Display .....	12
4.3	Keypad.....	13
4.4	Access Code.....	13
4.5	Startup .....	13
4.6	Shut Down .....	14
5.0	OPERATION.....	14
5.1	Main Menu .....	14
5.2	Sensor Menu.....	16
5.3	Control 1 - 4 Menus .....	18
5.4	4-20 mA 1 and 2 Menus (Optional).....	23
5.5	Time Menu .....	24
5.6	Access Code Menu.....	25
5.7	Datalog Menu.....	26
5.8	Config Menu.....	28
5.9	Upgrade Menu .....	29
6.0	Maintenance.....	30
6.1	Sensor Maintenance.....	30
6.2	Replacing the Fuses .....	31
7.0	TROUBLESHOOTING .....	31
7.1	Error Messages.....	31
8.0	SERVICE POLICY .....	33

## 1.0 INTRODUCTION

---

The Walchem WDIS Series controllers are wall mount disinfection controllers that provide two relays used to perform on/off or time proportional control of chlorine, chlorine dioxide, ozone or peracetic acid. Two additional relays are available for use as alarms or probe washing. A fifth output is used as a diagnostic alarm. One or two isolated 4-20 mA outputs are optional.

They are only compatible with Walchem sensors. The choice of the type of sensor is selected through the keypad. The sensors are temperature compensated internally; no temperature signal is transmitted to the controller. The controller will prompt you to calibrate the sensor at the desired frequency.

Our unique USB feature provides the ability to upgrade the software in the controller to the latest version.

An advanced USB capability option is available. The Configuration file feature allows you to save all the set points from a controller onto a USB flash disk, and then import them into another controller, making the programming of multiple controllers fast and easy. The data logging feature allows you to save the last 2 month's readings and events to a USB flash disk.

## 2.0 SPECIFICATIONS

### 2.1 Sensors

	Chlorine Dioxide	Peracetic Acid	Ozone	Chlorine
Range	0-20 mg/l	0-2000 mg/l	0-20 mg/l	0-20 mg/l
Resolution	0.01 mg/l	1 mg/l	0.01 mg/l	0.01 mg/l
Cross Sensitivity	Free Chlorine (5%), Ozone	Ozone, ClO <sub>2</sub> , H <sub>2</sub> O <sub>2</sub>	Free Chlorine (5%)	Bromine, Ozone, Iodine, ClO <sub>2</sub> , Di-/Trichloramine, or Bromamine
Flow Rate of Sample	30 to 100 liters/hour (0.13 to 0.44 gallons/minute)			
pH Range of Sample	1.0 – 14.0			6.8 – 8.0 (7.2 to 7.4 ideal)
Conductivity Range of Sample	50 to 10,000 µS/cm			Up to 4% NaCl
Response Time	30 sec	3 min	30 sec	30 sec

#### Electrical

Power Requirements	± 5 VDC, 5 mA maximum
Signal	0 to -2000 mVDC
Maximum Cable Length	1000 ft (305 m)
Cable Required	2 twisted pair, 22 AWG, shielded, 35 pF/ft (Walchem 100084 or Belden 8723)

#### Mechanical

Operating Temperature	0 to 50°C (32 to 122°F)	0 to 45°C (32 to 113° F)
Operating Pressure	0 to 1 atm (0 to 14.7 psi)	
Storage Temperature	0 to 50°C (32 to 122°F)	
Shelf Life	1 year	
Flow Cell Inlet	¼" NPTF	
Flow Cell Outlet	¾" NPTF	

#### Wetted Materials of Construction

Sensor Body	PVC, Polycarbonate	
Membrane	Silicone	PTFE
Flow Cell Body	Isoplast	
O-Ring	FKM	

### 2.2 Electrical: Input/Output

<b>Input Power</b>	100-240 VAC, 50/60 Hz, 8A Fuse: 1.0 ampere, 5 x 20 mm
<b>Input Signals</b>	
Sensor	±2000 mV
Interlock (optional)	Isolated, dry contact closure required (i.e., flow, level, etc.)
<b>Outputs</b>	
Control 1, Control 2 (ON/OFF)	Internally powered relays switching line voltage 6 A (resistive), 1/8 HP All relays are fused together as one group, total current for this group must not exceed 6A
Control 3, Control 4, Alarm	Dry contact relays 6 A (resistive), 1/8 HP
<i>Note:</i> The Alarm relay is non-programmable. Refer to the Main Menu diagram for the list of error conditions that trigger the alarm relay.	
4 - 20 mA 1 or 2 (optional)	Internally powered Fully isolated 600 Ohm max resistive load Resolution .001% of span Accuracy ± 1% of reading
Sensor Power	±5 VDC, 5 mA

**Agency Approvals**

UL	ANSI/UL 61010-1:2004, 2 <sup>nd</sup> Edition*
CAN/CSA	C22,2 No.61010-1:2004 2 <sup>nd</sup> Edition*
CE Safety	EN 61010-1 2 <sup>nd</sup> Edition (2001)*
CE EMC	EN 61326 :1998 Annex A*

Note: For EN61000-4-6,-3 the controller met performance criteria B.

\*Class A equipment: Equipment suitable for use in establishments other than domestic, and those directly connected to a low voltage (100-240 VAC) power supply network which supplies buildings used for domestic purposes.

**2.3 Mechanical (Controller)**

Enclosure Material	Polycarbonate
NEMA Rating	NEMA 4X
Dimensions	8.5" x 6.5" x 5.5"
Display	2 x 16 character backlit liquid crystal
Operating Ambient Temp	32 – 122°F (0 – 50°C)
Storage Temperature	-20 – 180°F (-29 – 80°C)

**2.4 WDIS Variables and their Limits**

		<b>Low Limit</b>	<b>High Limit</b>
<b>Sensor menu</b>			
	Days Between Calibration	0 days (no reminder)	59 days
<b>Temperature Menu</b>		No variables	
<b>Control 1 -4 Menus</b>			
	High or Low Set Point	0 ppm	20 ppm (2000 if PAA)
	High or Low Alarm Point	0 ppm	20 ppm (2000 if PAA)
	Dead Band	0.01	1.99 ppm (199 if PAA)
	Proportional Band	0.01 ppm	6.99 ppm (999 if PAA)
	Sample Period (set in min:sec)	0:01	30:00
	Time Limit (set in min:sec)	0:01	59:59 (enabled) 0=unlimited (disabled)
	Hold Time (Probe Wash)	0 seconds	99 seconds
	On Time (Probe Wash)	1 second	99 seconds
<b>4-20 mA 1 and 2 Menus</b>	4 & 20 mA Settings	0 ppm	20 ppm (2000 if PAA)
<b>Access Code Menu</b>	New Value	0	9999
<b>Datalog Menu (Optional)</b>		No variables	
<b>Config Menu (Optional)</b>		No variables	
<b>Upgrade Menu</b>		No variables	

\*Note: The Alarm relay is non-programmable. Refer to the Main Menu diagram for the list of error conditions that trigger the alarm relay.

## 3.0 UNPACKING & INSTALLATION

---

### 3.1 Unpacking the unit

Inspect the contents of the carton. Please notify the carrier immediately if there are any signs of damage to the controller or its parts. Contact your distributor if any of the parts are missing. The carton should contain: a WDIS series controller and instruction manual. Any options or accessories will be incorporated as ordered.

### 3.2 Mounting the electronic enclosure

The WDIS series controller is supplied with mounting holes on the enclosure. It should be wall mounted with the display at eye level, on a vibration-free surface, utilizing all four mounting holes for maximum stability. Use M6 (1/4" diameter) fasteners that are appropriate for the substrate material of the wall. The enclosure is NEMA 4X rated. The maximum operating ambient temperature is 122°F (50°C); this should be considered if installation is in a high temperature location. The enclosure requires the following clearances:

Top:	2" (50 mm)
Left:	8" (203 mm)
Right:	4" (102 mm)
Bottom:	7" (178 mm)

### 3.3 Installation

Once the enclosure is mounted, the metering pumps may be located at any distance from the controller. The sensor may be placed up to 1000 feet (305m) from the controller. Shielded cable with twisted pairs is required. Always route AC voltage wiring in conduit that is separated by 6 inches from low voltage DC signal lines (such as the sensor signal).

#### *Assembling the Sensor*



**CAUTION:** Wear gloves and safety glasses during assembly of the sensor since the electrolyte is a **STRONG ACID**. It is recommended to perform this operation over a sink with running water available. After using, re-cap any remaining electrolyte until the next use.

1. Remove the black protective tube from the electrode tip, and clean just the **tip** of the working electrode with the special abrasive paper supplied. Avoid touching the electrodes! Hold the pad with the special abrasive paper and rub the electrode tip over it, holding the electrode at a slight angle. Repeat several times at different angles.
2. Open the vial containing the membrane cap. Empty out the water. Make sure that only one gray band is in the groove covering the vent hole in the membrane cap. Fill the membrane cap to the top with the electrolyte fill solution. (The free chlorine membrane cap is shipped dry, and has only one band)
3. Hold the sensor body vertically with the tip pointing down and **SLOWLY** screw on the membrane cap until it is hand tight. **Be prepared for some electrolyte solution to squeeze out from the vent hole in the cap.**
4. Push the second gray band into the groove in the cap, making sure that the bands are smooth and flush.
5. Rinse your hands, the sensor, and all surfaces contaminated with electrolyte solution with running water. Check the sensor for leaks, especially at the membrane and the membrane cap threads. If any leaks are detected, tighten the membrane cap or replace it.
6. Push the cable onto the end of the sensor, aligning the pins with the holes. Turn the connector until hand tight to seal the cable connection.

## ***Flow Cell Placement***

Instructions for mounting the sensor into the process can vary greatly with the circumstances that are encountered in your application. Here are some general guidelines to assist you. Refer also to the typical installation drawings.

The sensor should be mounted such that the measuring surfaces will always stay wet. If the membrane dries out, it will respond slowly to changing disinfectant values for 24 hours, and if dried out repeatedly, will fail prematurely.

The flow cell should be placed on the discharge side of a circulation pump or downhill from a gravity feed. Flow into the cell must come from the bottom side that has the 3/4" x 1/4" NPT reducing bushing installed. **The reducing bushing provides the flow velocity required for accurate readings and must not be removed!**

A "U" trap should be installed so that if the flow stops, the sensor is still immersed in the water. The outlet of the flow cell must be plumbed to open atmosphere unless the system pressure is at or below 1 atmosphere. If the flow through the line cannot be stopped to allow for cleaning and calibration of the sensor, then it should be placed in a by-pass line with isolation valves to allow for sensor removal. Install the sensor vertically, with the measuring surface pointing down, at least 5 degrees above horizontal. (Refer to Installation drawings)

Flow rate regulation must be done upstream from the sensor, because any flow restriction downstream can increase the pressure above atmospheric and damage the membrane cap!

The sensor should be installed in an area where there is good solution movement and where it will respond rapidly to chemical additions. The placement of the sensor relative to the placement of chemical replenishment, along with the quality of the mixing, and the replenishment chemical flow rate are critical to accurate process control.

## ***Installing Sensor into Flow Cell***

1. Assemble the flow cell as shown below from the top down. The reducer should already be installed in the flow cell body.
2. Slide the 102586 nut over the membrane end of the sensor, followed by the 103419 top washer, followed by the 103422 o-ring, followed by the 103419 bottom washer (concave side up), followed by the 103421 clip ring. The clip ring must be pushed up until it snaps into the groove in the sensor body.
3. Place the 102594 o-ring in the top o-ring groove of the 102881 flow cell body.
4. Place the sensor body into the flow cell body, and tighten the 102586 nut until it is hand-tight. Before tightening completely, pull the sensor up until the clip ring is up against the bottom washer.
5. Insert the 191303 cable into the connector at the top of the sensor. The connector is keyed and will only insert in one orientation.

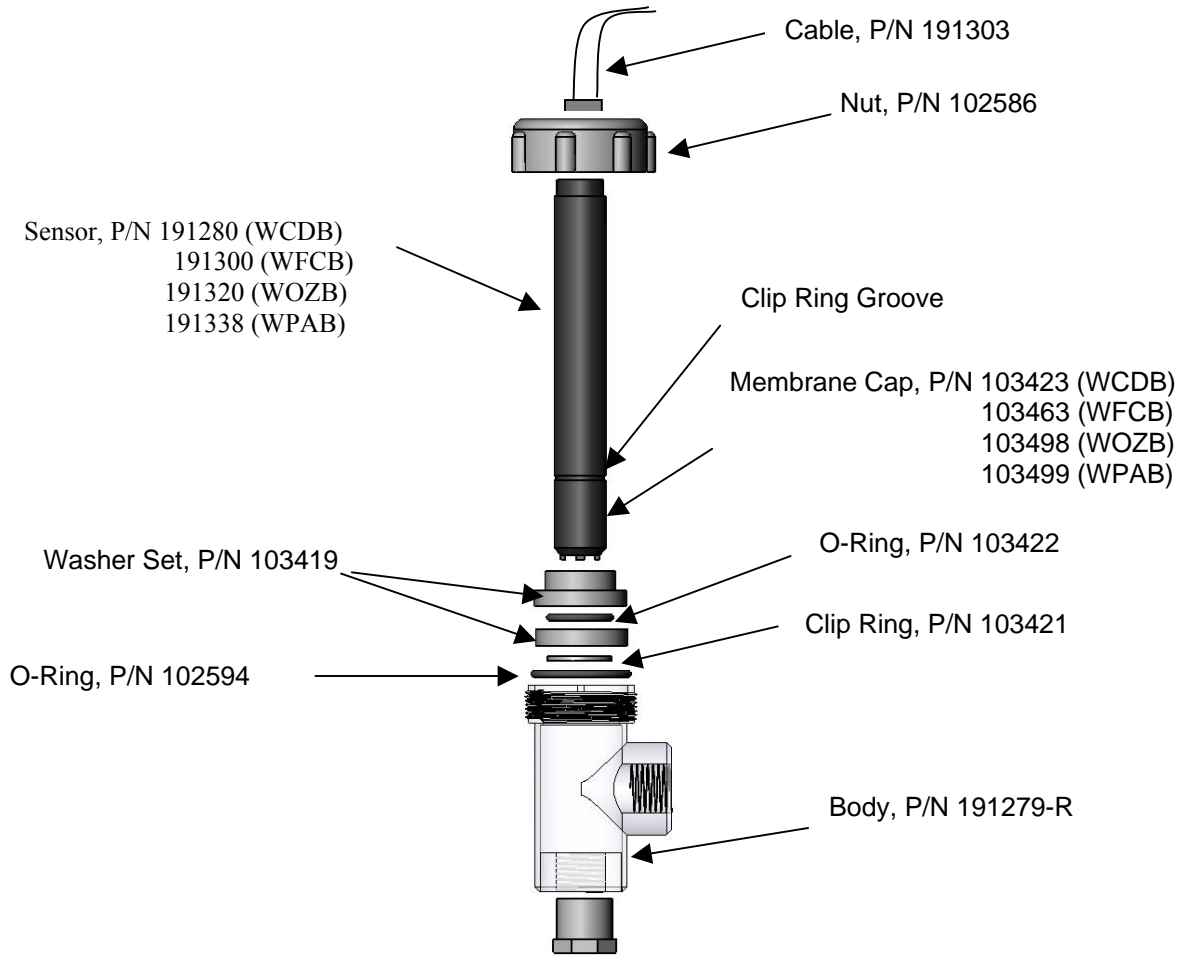

### 3.4 Icon Definitions

Symbol	Publication	Description
	IEC 417, No.5019	Protective Conductor Terminal
	IEC 417, No. 5007	On (Supply)
	IEC 417, No. 5008	Off (Supply)
	ISO 3864, No. B.3.6	Caution, risk of electric shock
	ISO 3864, No. B.3.1	Caution

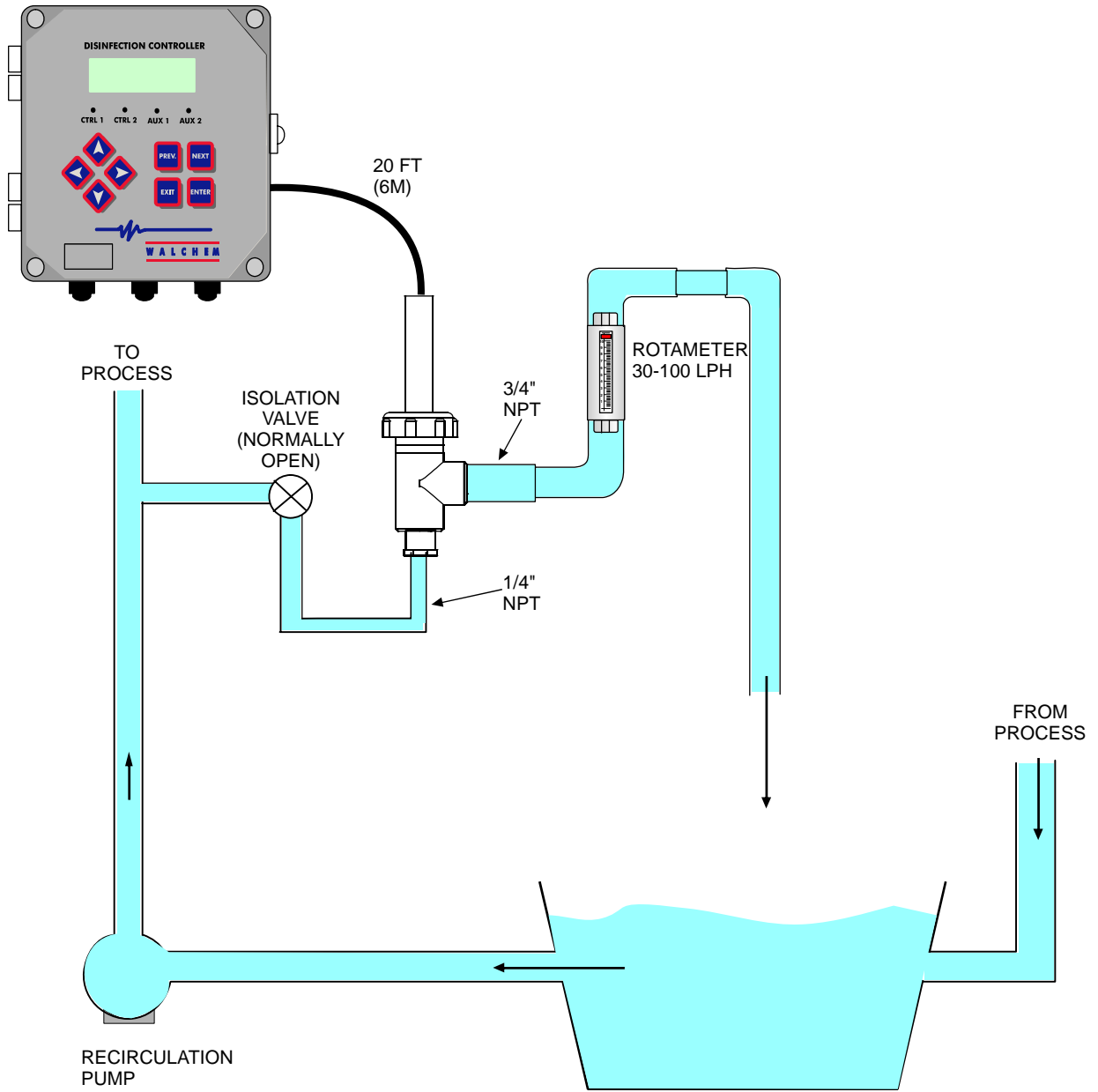

**Figure 1 Typical Installation**

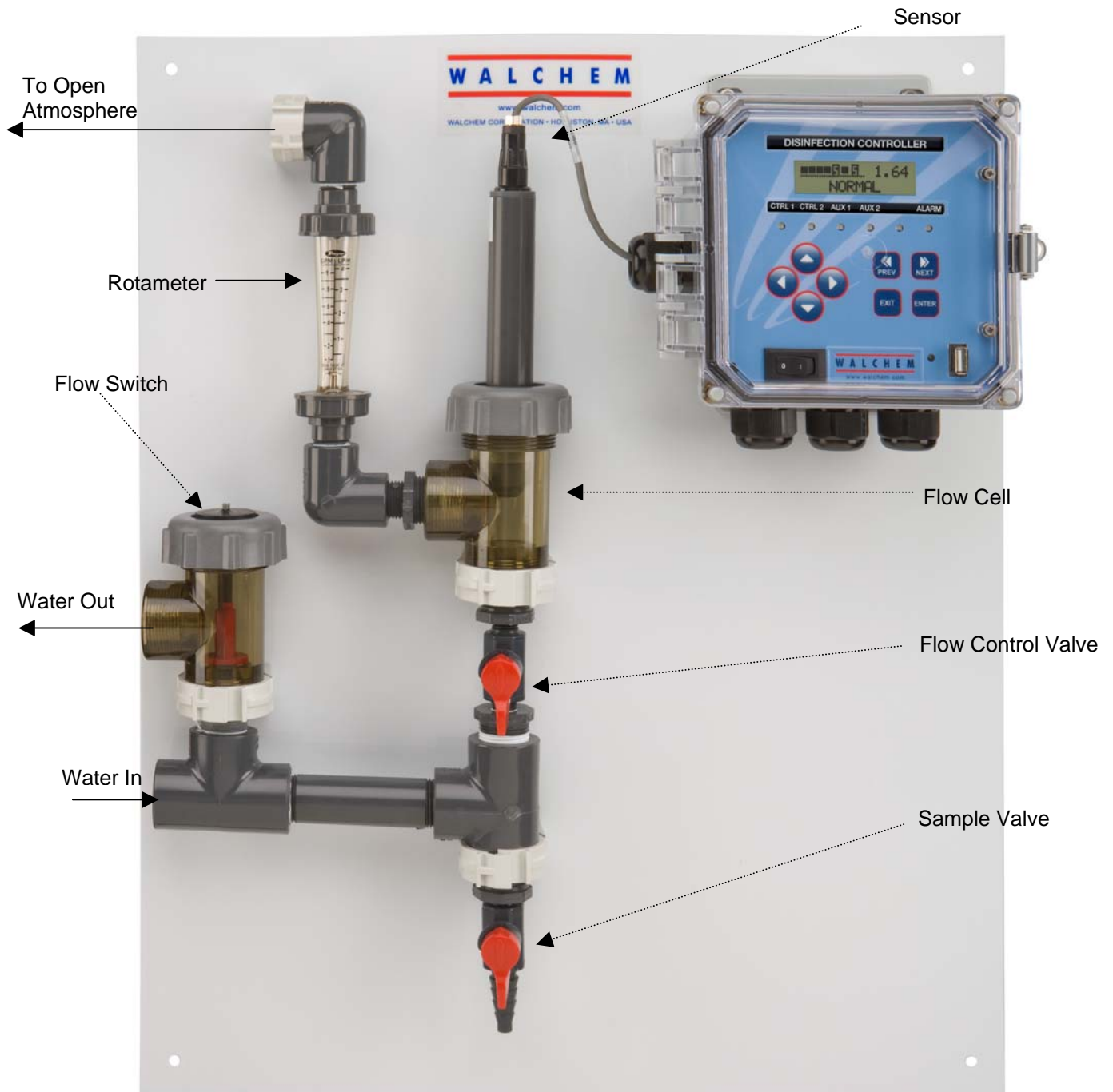



***Typical Installation Using Walchem Manifold***

### 3.5 Electrical installation

The various standard wiring options are shown in figure 2. Your WDIS series controller will arrive from the factory prewired or ready for hardwiring. Depending on your configuration of controller options, you may be required to hardwire some or all of the input/output devices. Refer to figures 3 and 4 for circuit board layout and wiring.

Note: when wiring the optional 4-20 mA output or a remote interlock switch, it is advisable to use stranded, twisted, shield pair wire between 22-26 AWG. Shield should be terminated at the controller ground stud (see figures 3 and 4).

	<h2>CAUTION</h2>	
<ol style="list-style-type: none"><li>1. There are live circuits inside the controller even when the power switch on the front panel is in the OFF position! The front panel must never be opened before power to the controller is REMOVED! If your controller is prewired, it is supplied with a 8 foot, 18 AWG power cord with USA style plug. A tool (#1 Phillips driver) is required to open the front panel.</li><li>2. When mounting the controller, make sure there is clear access to the disconnecting device!</li><li>3. The electrical installation of the controller must be done by trained personnel only and conform to all applicable National, State and Local codes!</li><li>4. Proper grounding of this product is required. Any attempt to bypass the grounding will compromise the safety of persons and property.</li><li>5. Operating this product in a manner not specified by Walchem may impair the protection provided by the equipment.</li></ol>		

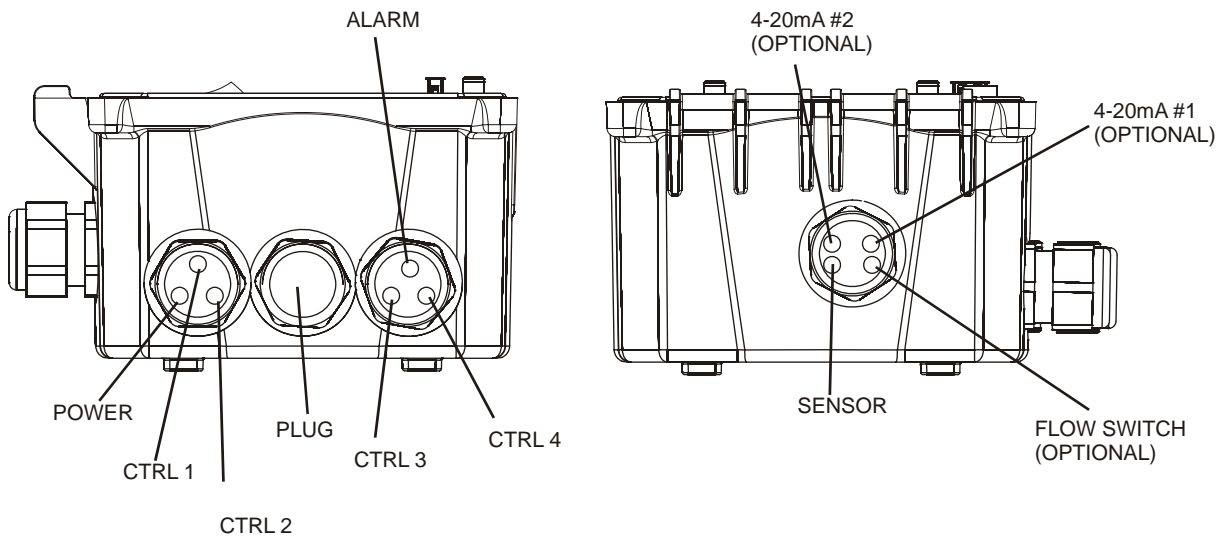

**Figure 2 WDIS410 Conduit Wiring**

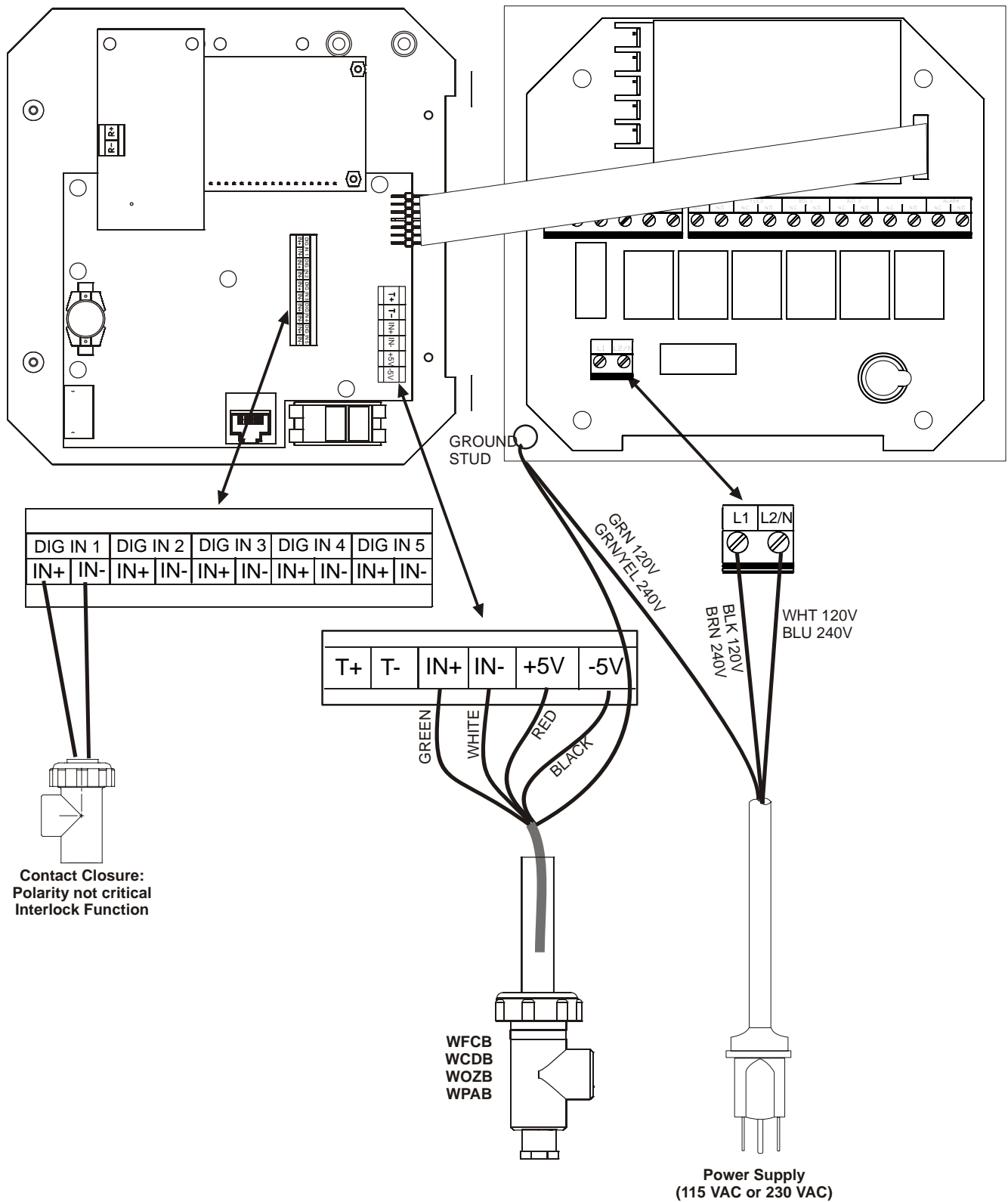
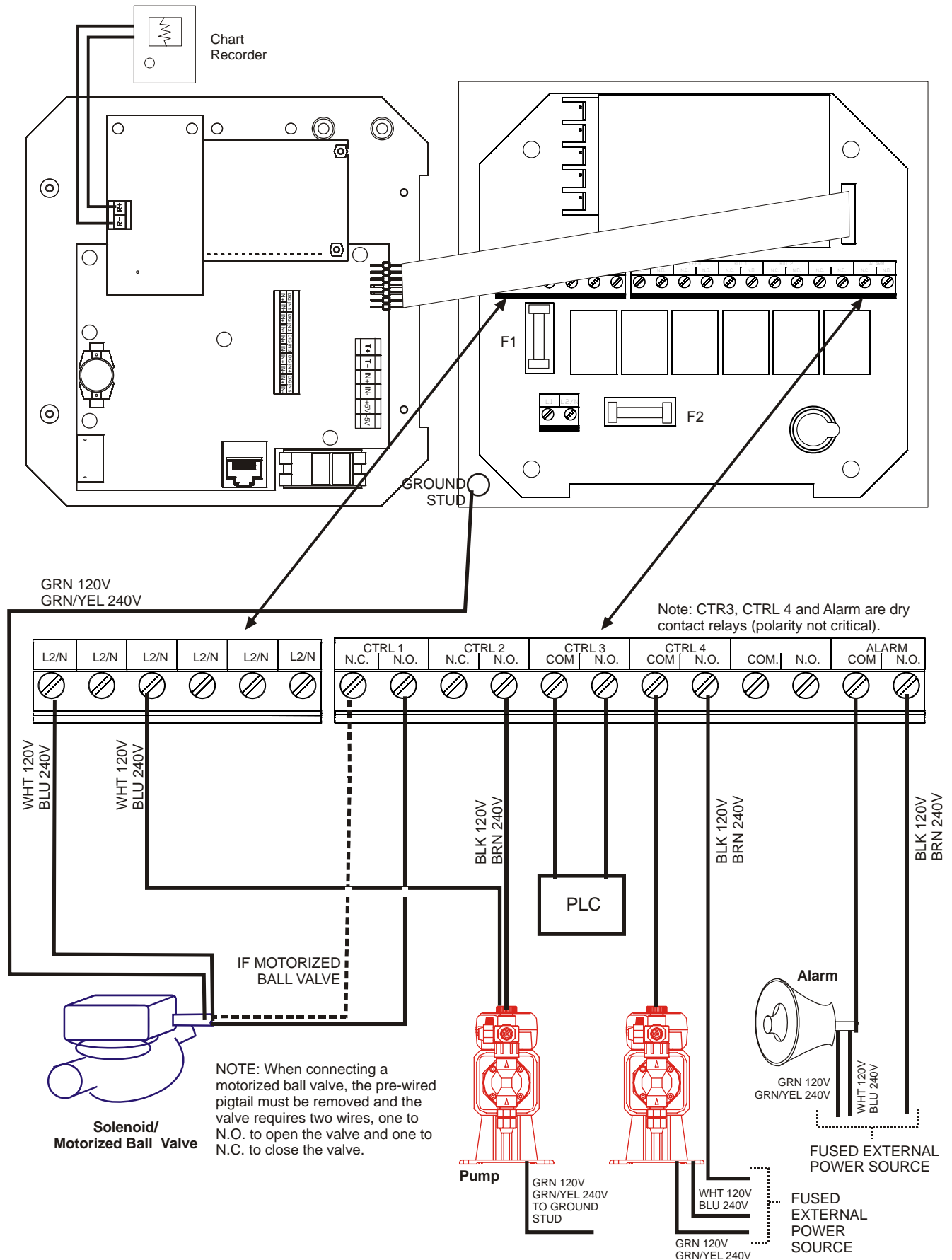

Figure 3 Wiring WDIS Inputs



**Figure 4 Wiring WDIS410 Outputs**

## 4.0 FUNCTION OVERVIEW

### 4.1 Front Panel

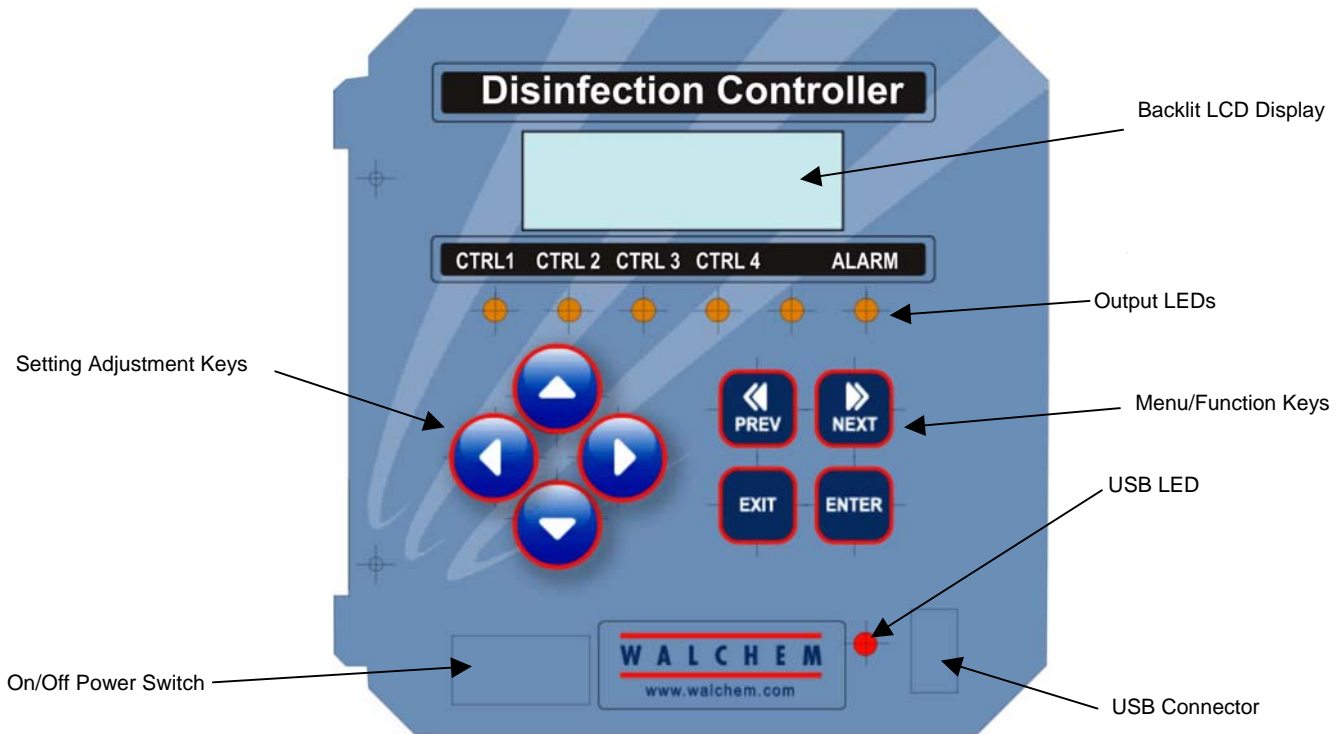

**Figure 5 Front Panel**

### 4.2 Display

A summary screen is displayed while the WDIS controller is on. This display shows a bar graph of the process value relative to the set point, a digital display of the process value, and the current operating conditions.

Towards the center of the bar graph are the (S)'s, which represent the set points. The bar graph grows from the left hand side, and the point furthest to the right indicates where the process value is relative to the set points.

The bottom line of the summary screen displays the following potential status messages: Probe Error, Temp Sensor Err, Calibration Time, Output Timeout, High/Low Alarm, Range Alarm, In Range Output, Output On, Probe Wash, Probe Wash Hold, Normal and Interlock



**Figure 6 Summary Screen**

### 4.3 Keypad

The keypad consists of 4 directional arrow keys and 4 function keys. The arrows are used to move the adjustment cursor and change settings, while the function keys are used to enter values, and navigate the various menu screens. The function keys are **ENTER**, **EXIT**, **NEXT**, and **PREV** (previous). **NEXT** and **PREV** scroll through the various menu choices. **ENTER** is used to enter a submenu and to enter a value. **EXIT** is used to back up one menu level. If you are at the main menu level, **EXIT** will return you to the Summary Display.



To change a value in a submenu, the left/right arrow keys move the cursor left and right to each digit or option that can be changed. The up/down arrows will change numeric values up or down, or scroll through option choices. Press **ENTER** only when you have finished making all of the changes for that menu screen.

### 4.4 Access Code

The WDIS series controller is shipped with the access code disabled. If you wish to enable it, see Section 5.6 for operation. With the access code enabled, any user can view parameter settings, but not change them. Note that this provides protection only against casual tampering. Use a lock on the cover latch if you need more protection.

### 4.5 Startup

#### *Initial Startup*

After having mounted the enclosure and wired the unit, the controller is ready to be started.

Plug in the controller and turn on the power switch to supply power to the unit. The display will briefly show the WDIS model number and then revert to the normal summary display. Scroll through the menus and calibrate the sensor reading, and set the control parameters detailed in Section 5, Operation.

To return to the summary display, press the **EXIT** key until you return to this screen. The controller will automatically return to this screen after 10 minutes.

#### **Conditioning**

The sensor requires conditioning to acclimate the electrodes prior to generating stable readings. Conditioning consists of installing the sensor in the flow cell, ensuring that the sensor remains wet at all times and supplying power to the sensor.

The following conditioning times are recommended:

New Sensor: 12-24 hours

After membrane or electrolyte replacement: 1 hour

#### *Normal Startup*

Startup is a simple process once your set points are in memory. Simply check your supply of chemicals, turn on the controller, calibrate it if necessary and it will start controlling.

## 4.6 Shut Down

To shut the WDIS controller down, simply turn off the power. Programming remains in memory.

**The sensor must be stored with the measuring surfaces wet.** If an extended shutdown will result in the sensor dehydrating, it must be removed from its position in the process and stored in a clean, dry place, without electrolyte in the cap. To reinstall, follow the directions in section 3.3.

## 5.0 OPERATION

---

These units control continuously while power is applied. Programming is accomplished via the local keypad and display.

To view the top level menu, press any key. The menu structure is grouped by inputs and outputs. Each input has its own menu for calibration and unit selection as needed. Each output has its own setup menu including set points, timer values, direction of control, etc. as needed. After ten minutes of inactivity in the menu, the display will return to the summary display. Keep in mind that even while browsing through menus, the unit is still controlling.

### 5.1 Main Menu

The exact configuration of your WDIS controller determines which menus are available as you scroll through the settings. Certain menus are only available if you purchase certain options. All settings are grouped under the following main menu items.

Sensor	
Control 1	
Control 2	
Control 3	
Control 4	
Time	
4-20mA 1	Only if 4-20mA option installed
4-20 mA 2	Only if 2nd 4-20mA option installed
Access Code	
Datalog	Only if advanced USB feature is in model code
Config	Only if advanced USB feature is in model code
Upgrade	

The **NEXT** key travels forward through this list while the **PREV** key travels backwards through the list. Pressing **ENTER** will Enter the lower level menu that is currently displayed.

Possible Status Screens

- \* Probe Error
- Probe Wash
- Probe Wash Hold
- \* Interlock
- \* Output Timeout
- \* Calibration Time
- Range Alarm
- In Range Output
- High/Low Alarm
- Output 1 On
- Output 2 On
- Output 3 On
- Output 4 On
- Normal

\* These status screens indicate that the diagnostic alarm relay is activated.

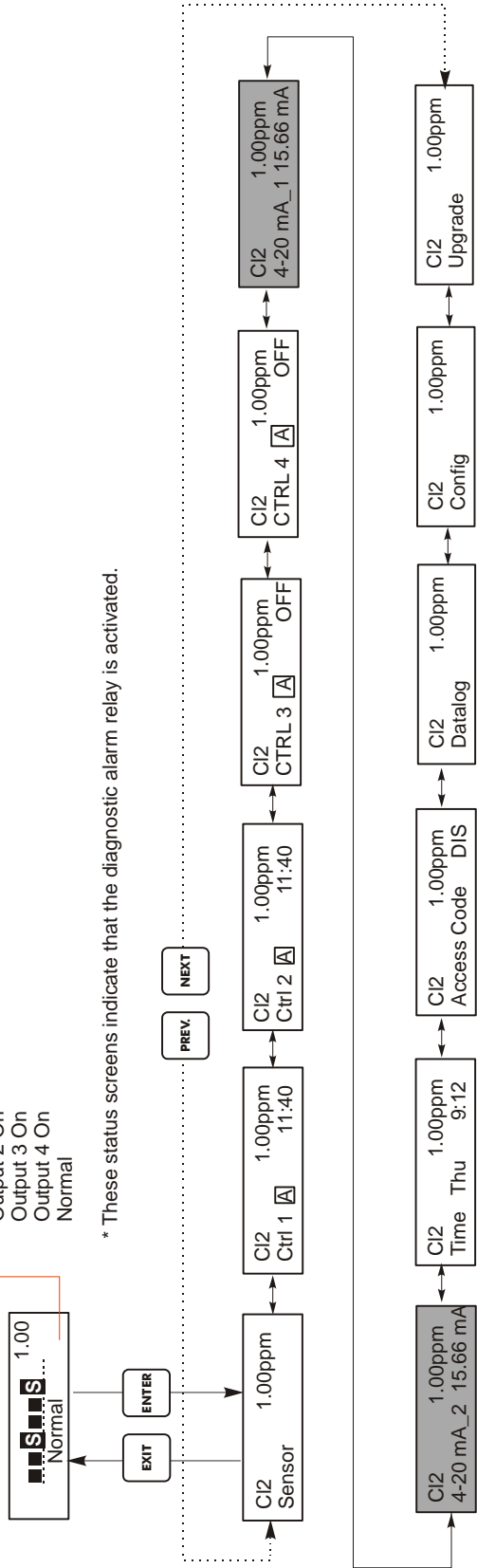

Legend



4-20mA menu is only present if 4-20mA option is installed.

Operation

Press Enter key to enter menu or submenu.  
 Press Exit key to exit menu.  
 After 10 minutes of inactivity the controller will automatically return to the summary screen.

Figure 7 Main Menu

## 5.2 Sensor Menu

The sensor menu provides the following settings: Calibration history (informational only), 1 point calibration, zero calibration, sensor type selection, and other sensor setup menus. Each is discussed in detail below. Refer to the Sensor Menu chart on the next page.

**Note:** If you are programming the unit for the first time you must set the Sensor Type first, selecting between Chlorine (CL2), Chlorine Dioxide (ClO2), Ozone, or Peracetic Acid. See below.

Cal'd	Displays the date of the last electrode calibration.
Calibration	Press <b>ENTER</b> to perform a 1 point process calibration of the sensor. With the sensor installed in the flow cell, and a sample circulating at the normal flow rate, and the oxidizer concentration at the normal level, press <b>ENTER</b> at the Calibration screen. The display will show a ppm reading. If this does not match the known ppm as measured by a test kit or titration, use the arrow keys to change the displayed value and press <b>ENTER</b> .
Cal Successful/Cal Failed	If the sensor response is good, then the display will read "Cal Successful". If the controller cannot calculate an acceptable slope from that mV reading, it will read "Cal Failed". A failure usually means that the sensor needs to be cleaned or replaced.
Zero Calibration	This menu is used to calibrate the sensor to read precisely zero in pure water. It should be set at installation with the sensor in air or pure water. This zero procedure should be repeated if a new sensor is installed. Press <b>ENTER</b> to start the zero adjust procedure. When asked "SnsrInPureWater?", remove the sensor from the flow cell and dry it off. Alternatively, supply the flow cell with a sample of water without any oxidizer in it. Use the arrow key to change the "N" to "Y" and press <b>ENTER</b> . You will be asked to press <b>ENTER</b> when the mV reading on the top line is stable. If the sensor offset was less than $\pm 100$ mV, the display will flash "SensorCalSuccess" and return to the Zero Calibration display. You may now press <b>EXIT</b> . If the message "BadZero: CalFail" appears, the offset was too large for the software to compensate. Check to see that the sensor is out of the bath and is dry and that all wiring connections are correct. If none of these corrects the problem, install a new sensor.
Days Btwn Cal	Use the arrow keys to set the number of days that you would like to go by before recalibrating the electrode. The controller will prompt you to recalibrate when that time has expired. Setting the number of days to zero will disable this feature.
Sensor mV	This menu displays the mV from the electrode. It is useful for troubleshooting.
Self Test	Press <b>ENTER</b> to perform a self-test. If it says "FAIL" in the upper right hand corner, this indicates a problem with the controller which should be returned for repair. If it passes, and you have a problem calibrating, it is an electrode or preamp problem.
Sensor Type	Press <b>ENTER</b> to set up the controller to match the type of sensor to be used. Use the Up and Down arrows to toggle between Cl2 (chlorine), ClO2 (chlorine dioxide), Ozone and Peracetic Acid, then press <b>ENTER</b> to make your selection. The controller will warn you to check your set points because the acceptable range of set points may have changed. Press any key to clear the warning message.

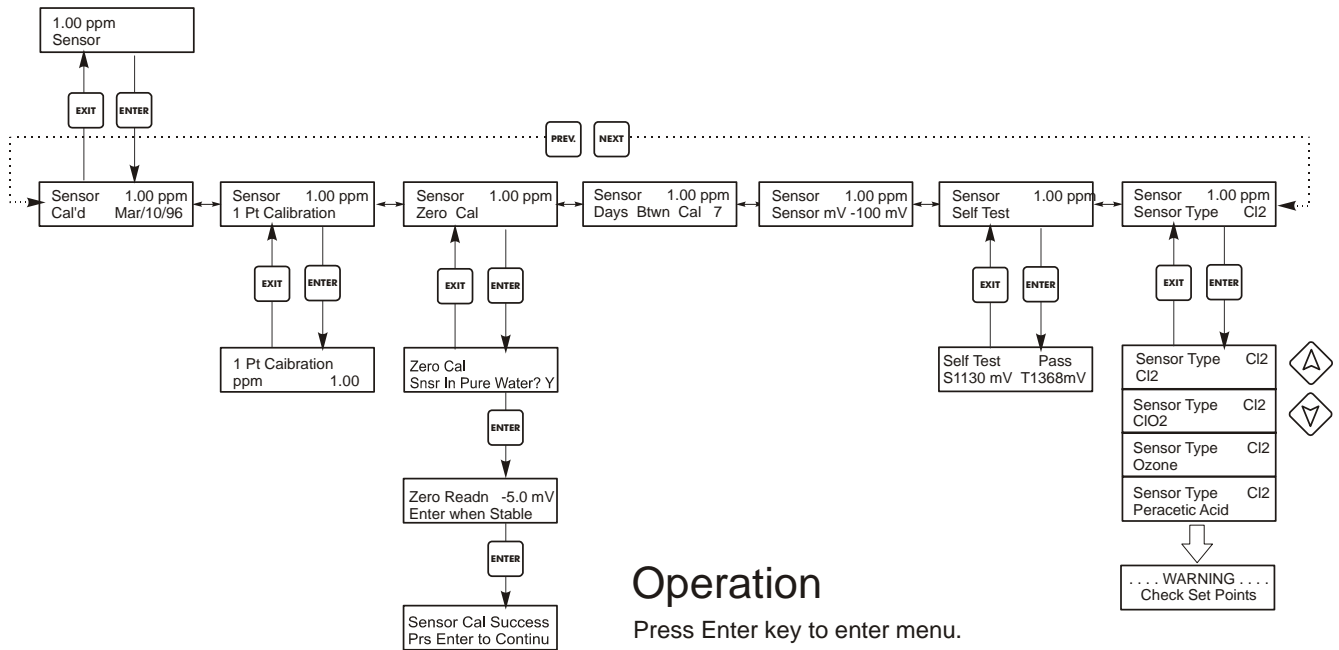

## Operation

Press Enter key to enter menu.

Press Exit key to exit menu.

Blinking fields may be edited with the adjust arrows.

Press Enter when modification is complete to return to Main Menu Level.

**Figure 8 Sensor Menu**

### 5.3 Control 1 - 4 Menus

The Control 1 - 4 menus are separate from each other but operate in exactly the same way. Each menu provides the following independent settings: Set Point, Dead Band, Time Limit, Interlock, Output Mode, Assign Input, HOA, Set Point, Dead Band, and Time Limit. The Control menu will be indicated on the display by one of the following: (The 'A' indicates that the output is being controlled automatically.)

**NOTE: When programming the unit for the first time, go to the “Mode” menu to select how that output will operate. Making this assignment first will bring up the correct menus for the Mode you are using.**

- Ctrl 1 A        **OFF**     Indicates that the output is currently OFF.
- Ctrl 1 A        **10:00**    Indicates the length of time that the output has been ON.
- Ctrl 1 A        **Intrck**    Indicates that control has been suspended because the Interlock switch is Open
- Ctrl 1 A        **TIMEOUT**    Indicates that the output has been on longer than the Time Limit.

<b>Mode</b>	Press the <b>ENTER</b> key to change the mode in which the output will operate. The relays may be a low set point, a high set point, a low alarm, a high alarm, an out-of-range alarm, an in-range output, or a probe wash. Use the arrow keys to scroll through the choices.
	<p><b>Low Set Point</b></p> <p>Press <b>ENTER</b> when this is displayed to select a low set point. The relay will close when the process value goes below the set point value. The summary screen will display that the output is on. A time limit menu will be available, to prevent runaway control. An Interlock menu will be available to allow you to stop control if flow past the sensor stops.</p>
	<p><b>High Set Point</b></p> <p>Press <b>ENTER</b> when this is displayed to select a high set point. The relay will close when the process value goes above the set point value. The summary screen will display that the output is on. A time limit menu will be available, to prevent runaway control. An Interlock menu will be available to allow you to stop control if flow past the sensor stops.</p>
	<p><b>Low Alarm</b></p> <p>Press <b>ENTER</b> when this is displayed to select a low alarm. The relay will close when the process value goes below the set point value. The summary screen will display “Low Alarm”. No time limit or interlock features will be available.</p>
	<p><b>High Alarm</b></p> <p>Press <b>ENTER</b> when this is displayed to select a high alarm. The relay will close when the process value goes above the set point value. The summary screen will display “High Alarm”. No time limit or interlock features will be available.</p>
	<p><b>Out Range Alarm</b></p> <p>Press <b>ENTER</b> when this is displayed to select an out-of-range alarm. The relay will close when the process value is either above or below the two set point values. The summary screen will display “Range Alarm”. No time limit or interlock features will be available.</p>
	<p><b>In Range Output</b></p> <p>Press <b>ENTER</b> when this is displayed to select an in-range output. The relay will close when the process value is between the two set point values. The summary screen will display “In Range Output”. No time limit or interlock features will be available.</p>
	<p><b>Time Prop Hi</b></p> <p>Press <b>ENTER</b> when this is displayed to use time proportional control with a high set point. In Time Proportional Mode, the farther away from the set point the system is, the longer the ON time. Refer to the drawings below for an illustration of Time Proportional Mode.</p>

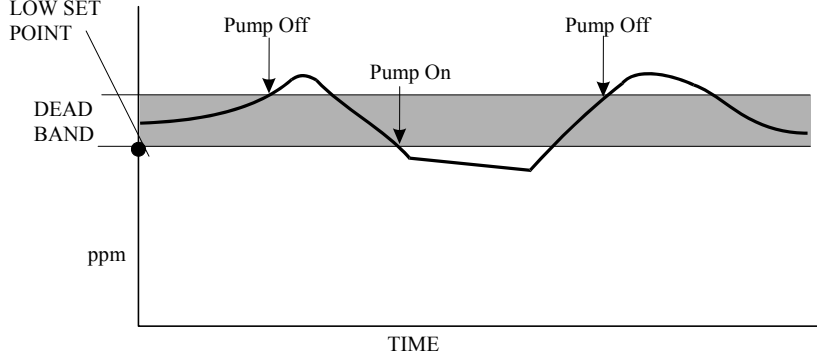
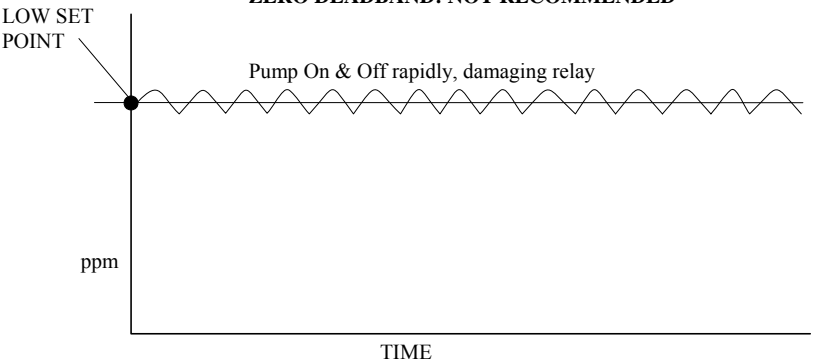
<b>Mode (continued)</b>	<b>Time Prop Lo</b> Press ENTER when this is displayed to use time proportional control with a low set point. In Time Proportional Mode, the farther away from the set point the system is, the longer the ON time. Refer to the drawings below for an illustration of Time Proportional Mode.  <b>Probe Wash</b> Press ENTER when this is displayed if you want to use the relay to interrupt control and activate a pump or valve to wash down the electrode. The summary screen will display "Probe Wash".
<b>Low Set Point</b>	Only appears if the Mode is Low Set Point Press <b>ENTER</b> if you want the Control relay to close if the process goes below a certain value. The status screen message will be Output ON. This denotes a normal correction of the process value. If you want the status message to be Low Alarm, indicating a problem, choose an Output Mode of Low Alarm as described below.
<b>High Set Point</b>	Only appears if the Mode is High Set Point Press <b>ENTER</b> if you want the Control relay to close if the process above a certain value. The status screen message will be Output ON. This denotes a normal correction of the process value. If you want the status message to be High Alarm, indicating a problem, choose an Output Mode of High Alarm as described below.
<b>Low Alarm</b>	Only appears if the Mode is Low Alarm, In Range or Out of Range Press <b>ENTER</b> if you want the Control relay to close if the process goes below a certain value. The status screen message will be Output ON. This denotes a normal correction of the process value. If you want the status message to be Low Alarm, indicating a problem, choose an Output Mode of Low Alarm as described below.
<b>High Alarm</b>	Only appears if the Mode is High Alarm, In Range or Out of Range Press <b>ENTER</b> if you want the Control relay to close if the process above a certain value. The status screen message will be Output ON. This denotes a normal correction of the process value. If you want the status message to be High Alarm, indicating a problem, choose an Output Mode of High Alarm as described below.
<b>Dead Band</b>	<p>Use the arrow keys to set the desired dead band, then press <b>ENTER</b>. If the set point is 7.00 ppm, and the dead band is 0.05 ppm, then the relay will close at 7.00 ppm and open 0.05 ppm away from 7.00.</p>  <p style="text-align: center;"><b>ZERO DEADBAND: NOT RECOMMENDED</b></p> 

<h3>Proportional Band</h3>	<p>This menu only appears if Time Proportional control mode is selected.</p> <p>The proportional band menu sets the deviation from set point at which the control output will be on for the entire sampling period.</p> <p>The volume added at the worst case deviation can be calculated by multiplying the pump flow rate by the sample period time (for example, 1 gal per minute flow rate x 2 min sample period = 2 gal of chemical added). Then calculate the effect on the concentration of this addition (for example, if a 2 gal addition will raise the ppm by 0.5 then the proportional band should be set to 0.5).</p> <p>If the proportional band is set too low, then the controller could overshoot the set point. If it is set too high, then the controller may never be able to reach the set point.</p> <p>Figures below show a dechlorination example of Time Proportional Mode with the following program parameters:</p> <table border="0" style="margin-left: 40px;"> <tr> <td>Control Mode</td> <td>Time Prop Hi</td> </tr> <tr> <td>Sample Period</td> <td>10 minutes</td> </tr> <tr> <td>High Set Point</td> <td>0.00 ppm</td> </tr> <tr> <td>Proportional Band</td> <td>1.00 ppm</td> </tr> </table> <p>In the example figures, the set point is 0.00 and the Proportional Band is 1.00. Note that when the ppm goes above the set point, the control relay is ON for a short period of time. As the ppm increases, the control relay is ON for a longer period of time. When the reducing agent starts to affect the bath concentration and the ppm is reduced, the control relay is ON for a shorter period of time. When the ppm drops below the set point of 0.00, the control relay is OFF all the time.</p>	Control Mode	Time Prop Hi	Sample Period	10 minutes	High Set Point	0.00 ppm	Proportional Band	1.00 ppm
Control Mode	Time Prop Hi								
Sample Period	10 minutes								
High Set Point	0.00 ppm								
Proportional Band	1.00 ppm								
<h3>Sample Period</h3>	<p>This menu only appears if Time Proportional control mode is selected.</p> <p>It allows setting the sampling period from 0 to 30:00 minutes. This is the time that will elapse between checking the sensor input reading for deviation from set point. The Proportional Band setting and how far the current reading is from the set point will determine the amount of time that the relay remains on.</p> <p>The sample period should be set to approximately 1½ times the amount of time that it takes for the sensor to react to an addition of chemical. This can be determined by making a manual addition of chemical using the HOA menu and timing how long it takes for the controller to react.</p> <p>Setting the sample period too low will result in a second addition being made before the first is detected and you will overshoot the set point. Setting too high will delay the next addition to the point that the set point may never be reached.</p>								
<h3>Time Limit</h3>	<p>This menu only appears if the output mode has been selected as a Low Set Point, or a High Set Point.</p> <p>Use the arrow keys to set the time limit (min:sec) for the output to be active, then press <b>ENTER</b>. If it is set for "0:00", no limit will be imposed, and the output could stay on forever.</p>								

Reset Timer	<p>This menu only appears if the output mode has been selected as a Low Set Point, or a High Set Point and the time limit has expired.</p> <p>Determine the reason that the output stayed on too long, and once the problem has been solved, press <b>ENTER</b> to reset the timer.</p>
Probe Wash Sched	<p>This menu only appears if the output mode has been selected as a Probe Wash.</p> <p>Press <b>ENTER</b> to program the probe wash schedule. The display will be "Event A 00:00 00". The first numbers are the time of day, in military time, when the probe wash will take place. The last two numbers are the time, in seconds, that the relay will be closed and the pump or valve attached to the relay will clean the probe. Use the arrow keys to change the time of day and the duration of the cleaning. When both values are set, press <b>ENTER</b>. If the electrode needs to be washed more than once a day, additional events may be accessed by pressing the NEXT key. Once all events are programmed, press <b>EXIT</b> to return to the top level menus.</p>
Hold Time	<p>This menu only appears if the output mode has been selected as a Probe Wash.</p> <p>Use the arrow keys to select the time delay in seconds between the probe wash ending and control beginning again. The hold time can be a maximum of 99 seconds. During the hold time, the summary display will indicate "Probe Wash Hold".</p>
Interlock	<p>Use the Up and Down arrows to toggle between Y(Yes) and N(No). Choosing Y means that the output will deactivate if the device attached to the controller is open. For example, if the electrode is installed in a recirculating pipe line, a flow switch that is closed if flow is sufficient and open if flow is insufficient may be installed in the line, so that if flow past the electrode stops, the controller will not pump in chemicals based on a stagnant sample. Similarly, a level switch may be attached to prevent control of an empty batch tank.</p>
HOA	<p>Use the Left and Right arrows to move between Hand, Off and Auto. In Hand (Manual) mode, the output will be turned on immediately for a maximum of 10 minutes. In the Off mode, the output will be turned off indefinitely. In the Auto mode, the output turns on and off in response to changes in the process value relative to the set point. The letter inside the block on the status screen indicates which mode the output is in.</p>

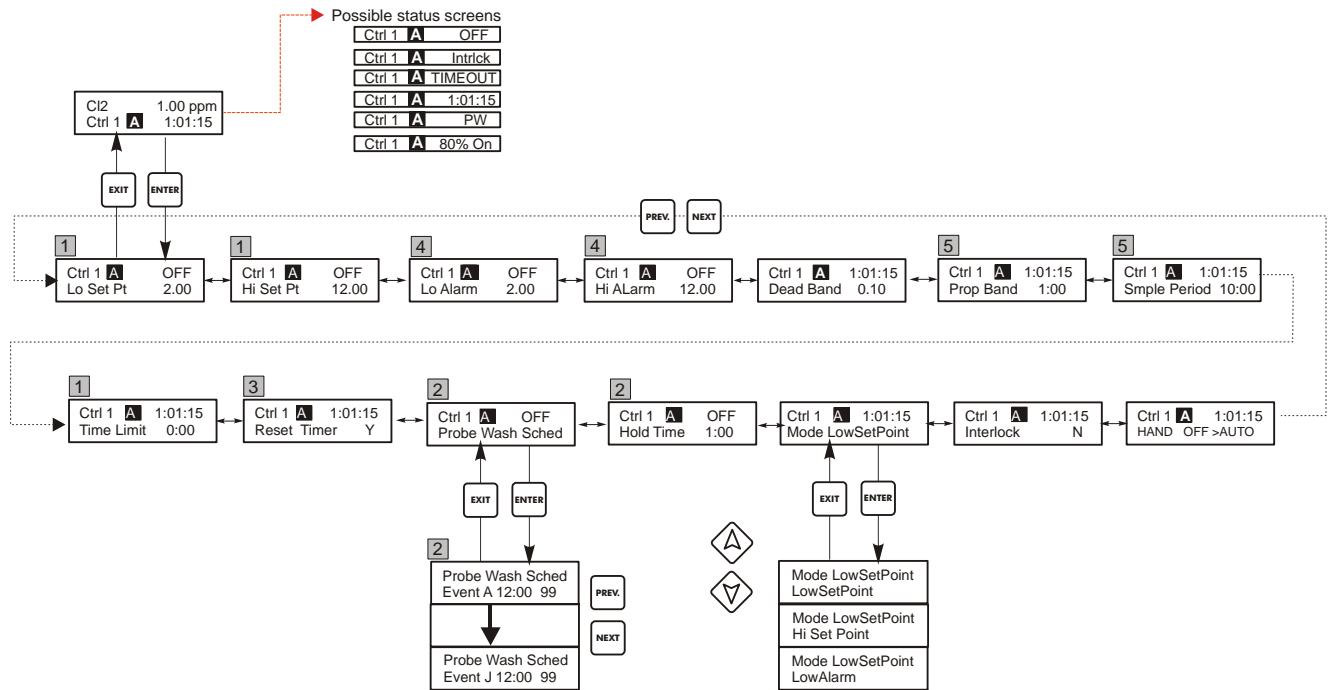

## Legend

- 1 Menu choices that appear only when Hi Set Point or Lo Set Point mode is selected. Set points appear as needed depending on output mode (i.e. the Low Set Point does not appear if Hi Set Point mode is selected). Neither set point appears if the Probe Wash mode is selected.
- 2 Menu choices that appear when Probe Wash mode is selected.
- 3 Appears only if limit timer has expired.
- 4 Menus appear only if Hi or Lo Alarm mode or Out of Range or In Range Output is selected. If Hi Alarm mode is selected, only Hi Alarm appears, etc. Both appear if In Range output or Out of Range Alarm is selected.
- 5 Menus appear only when Time Proportional Mode is selected.

## Operation

Press Enter key to enter menu.  
 Press Exit key to exit menu.  
 Blinking fields may be edited with the adjust arrows.  
 Press Enter when modification is complete to return to Main Menu Level.

**Figure 9 Control 1 - 4 Menu**

## 5.4 4-20 mA 1 and 2 Menus (Optional)

These menus will only appear if the optional 4-20 mA output board(s) is installed. They are used to set the scale of the 4-20 mA output. It contains the following menu selections: Set 4 mA Point, Set 20 mA Point, and Calibrate.

<b>4 mA Pt</b>	Use the arrow keys to enter the process value in ppm that you want to correspond to a 4 mA output from the controller.
<b>20 mA Pt</b>	Use the arrow keys to enter the process value in ppm that you want to correspond to a 20 mA output from the controller.
<b>Calibrate</b>	This menu is used to calibrate instruments connected to the mA output. The 4-20 mA output is extremely accurate and stable and therefore will never need calibration. This feature allows other devices to be calibrated at the 4 and 20 mA points. Press <b>ENTER</b> to start the calibration.
<b>Fixed 4 mA Out</b>	The controller will output 4.00 mA. Adjust the chart recorder or data logger per its instruction so that the process value displayed is what is expected for a 4.00 mA input.
<b>Fixed 20 mA Out</b>	As above, except that the controller will output 20.00 mA. The design of the 4-20 mA output is such that it should never need calibration. If the mA signal is not what it should be, call the factory for service.

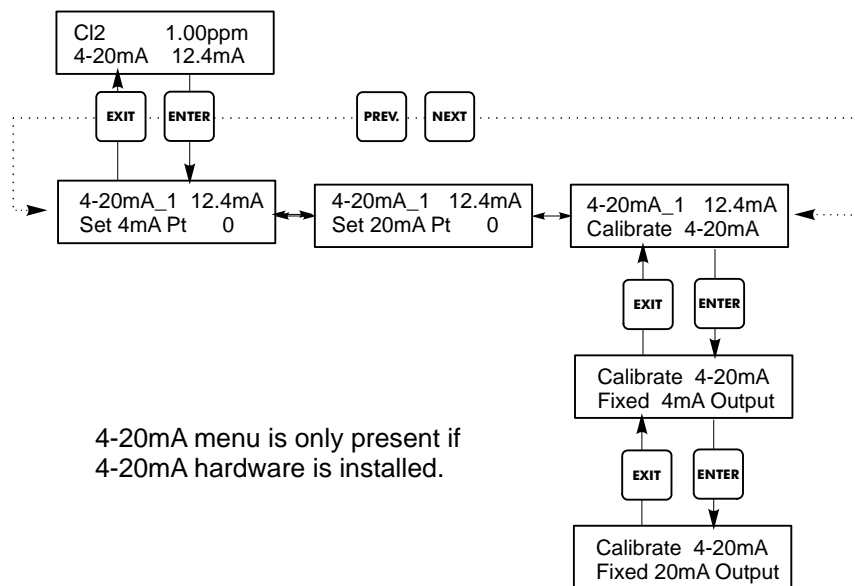
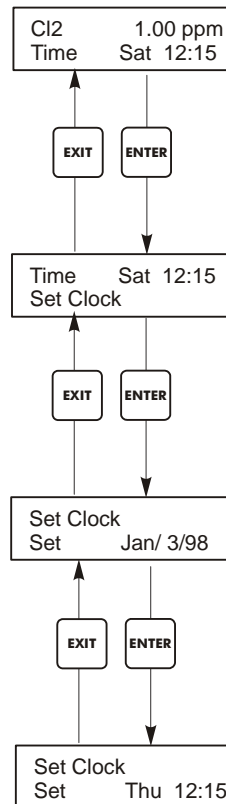

**Figure 10 4-20 mA 1 and 2 Menus**

## 5.5 Time Menu

The time menu is used to set the date and time that the controller uses to schedule probe washing and calibration prompts. There is only one menu selection: Set Clock.

<i>Set Time</i>	Press <b>ENTER</b> to set the clock. Use the arrow keys to change the year, date, and month, then press <b>ENTER</b> . Use the arrow keys again to set the day of the week and the time. Use military time (for example, 1:00 PM is 13:00). Press <b>ENTER</b> to return to the top level clock menu.
-----------------	---



**Figure 11 Time Menu**

## 5.6 Access Code Menu

This menu determines whether the access code feature of the controller is enabled or disabled and allows you to customize the access code to your own value. The access code controls whether or not you are allowed to change the parameters in the controller. With the access code disabled, any user may change any parameter. With the access code enabled, any user can view any parameter, but cannot change them. Once an attempt is made to change a parameter, the display will prompt the user to enter the access code. If the correct access code is entered, the parameters can be changed. If the wrong access code is entered the parameters cannot be changed. Once the access code has been correctly entered, it will remain valid until there is a period of 10 minutes without a key being pressed. The access code menu will appear as shown below:

Access Code	<b>DIS</b>	Indicates that the access code is disabled. No access code is required to change any setting.
Access Code	<b>REQ</b>	Indicates that the access code is required to alter settings.
Access Code	<b>OK</b>	Indicates that the access code is required and has been entered correctly.

<b>Enable N / Y</b>	Press the Up or Down arrow key to change the N to Y and press ENTER to enable the access code feature. If the access code is enabled you must first enter the access code to disable it.
<b>New Value</b>	<p>Press ENTER to display the current access code value and use the arrow keys to change it to any value between 0 and 9999. If the access code has been enabled, you will be prompted to enter the current access code before being allowed to change it. You must remember the access code if you enable it.</p> <p>The Factory default Access code is 1995.</p> <p>If you change the access code and can't remember it follow this procedure:</p> <ol style="list-style-type: none"> <li>1. Turn off power to the controller.</li> <li>2. Wait 10 seconds.</li> <li>3. Press and Hold the UP and DOWN arrow keys while turning on the power.</li> <li>4. Read the access code on the display.</li> <li>5. Release the keys, and the access code will disappear.</li> </ol>

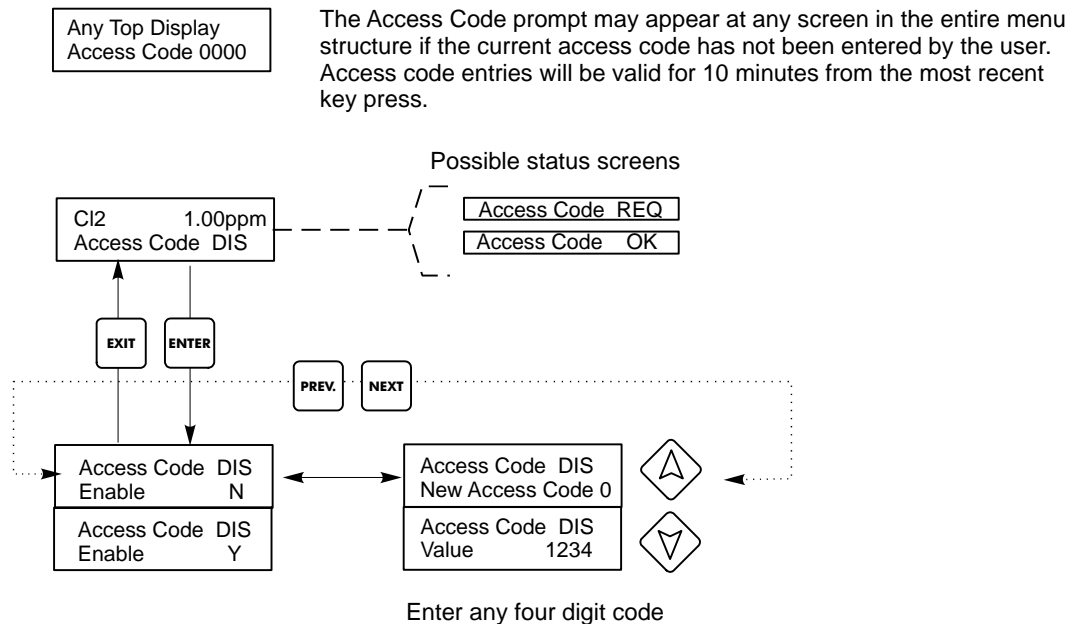

**Figure 12 Access Code Menu**

## 5.7 Datalog Menu

This menu is available if the data logging option has been purchased. This is indicated in the model code by the letter U at the end of the model code. This menu allows you to save data from the controller to a USB flash drive.

The controller has four logs, the Current Datalog, the Backup Datalog, the Event Log, and the Reset Log. All files are in a CSV format that may be opened in a spreadsheet such as Microsoft Excel.

<b>Current Datalog</b>	<p>Contains the following data taken at 10 minute intervals: Disinfectant ppm</p> <p>When the current datalog is downloaded to a USB stick, it is erased and a new log file is started. If the current datalog is not downloaded before it reaches its maximum size (at least 60 days of data) the oldest data is overwritten by the newest data.</p>
<b>Backup Datalog</b>	<p>Contains the same data as the current log but it is never erased. When the backup log reaches its maximum size (at least 60 days of data), the oldest data is overwritten by the newest data.</p>
<b>Event Log</b>	<p>Contains columns for each relay and flow switch input, as well as the date and time. Each time any of these change state, the date and time is updated and it will show a 1 if the relay is on and 0 if it is off, and a 1 if the flow switch indicates no flow, 0 if there is flow. Tens of thousands of events will be recorded before the oldest data is overwritten by the newest, the number varying with the controller's configuration.</p>
<b>Reset Log</b>	<p>Consists of time stamps of when power was lost, when it was returned, and the cause of the reset.</p>

<b>Current or Backup Datalog</b>	<p>Place a USB flash drive with at least 10 MB capacity into the USB port on the front panel of the controller. Press the Enter key to download the file from the controller to the disk. The file name for the Current Datalog will be Datalog&lt;serial number&gt;&lt;date&gt;&lt;time&gt;.csv using the date and time it was downloaded. The file name for the Backup Datalog will be Datalog&lt;serial number&gt;&lt;date&gt;&lt;time&gt;.csv using the date and time it was created.</p> <p>The controller will display the progress of the file download process. If the file was successfully copied to the USB disk the controller will display Transfer Success.</p>	
<b>Copy Event Log</b>	<p>Place a USB flash drive with at least 10 MB capacity into the USB port on the front panel of the controller. Press the Enter key to download the file from the controller to the stick. The file name will be Eventlog&lt;serial number&gt;&lt;date&gt;&lt;time&gt;.csv.</p> <p>The controller will display the progress of the file download process. If the file was successfully copied to the USB disk the controller will display Transfer Success, otherwise Transfer Fail 1.</p>	
	<b>Transfer Success</b>	<b>Transfer Fail 1</b>
<b>Copy Reset Log</b>	<p>Place a USB flash drive with at least 10 MB capacity into the USB port on the front panel of the controller. Press the Enter key to download the file from the controller to the stick. The file name will be Resetlog&lt;serial number&gt;&lt;date&gt;&lt;time&gt;.csv.</p> <p>The controller will display the progress of the file download process. If the file was successfully copied to the USB disk the controller will display Transfer Success.</p>	
	<b>Transfer Success</b>	<b>Transfer Fail 1</b>

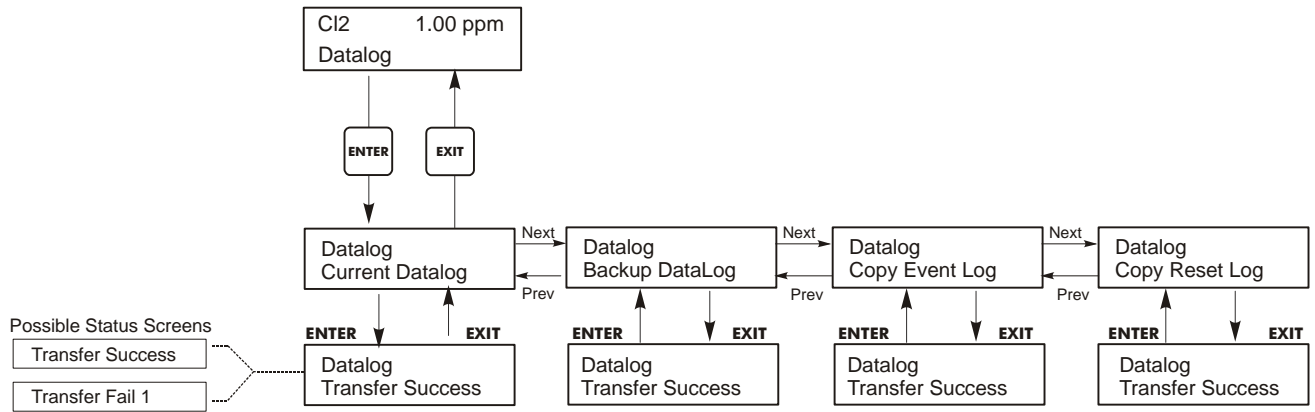
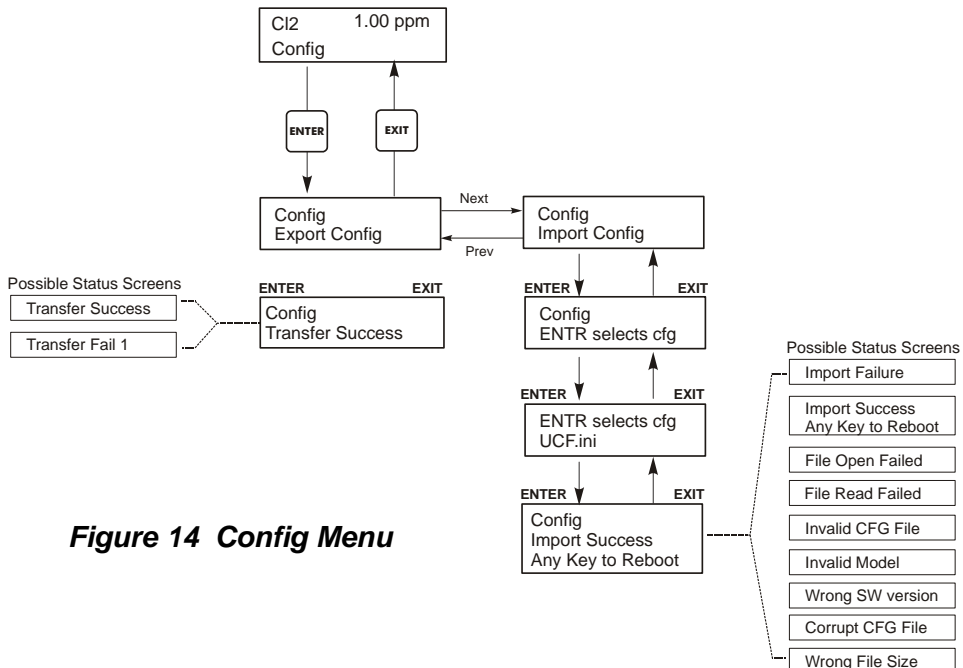

**Figure 13 Datalog Menu**

## 5.8 Config Menu

This menu allows you to export a file that contains all of the set points in the controller to a USB flash disk drive, and then later import the set points into another controller.

<b>Export Config</b>	Place a USB flash drive with at least 10 MB capacity into the USB port on the front panel of the controller. Press the Enter key to export the configuration file from the controller to the stick. The file name will be UCF.ini. If you are exporting files with different set points you may rename the file to something that describes it, as long as it has an ini extension.	
	The controller will display the progress of the file download process. If the file was successfully exported to the USB disk the controller will display Transfer Success, otherwise Transfer Fail 1.	
	<b>Transfer Success</b>	<b>Transfer Fail 1</b>
<b>Import Config</b>	Place a USB flash drive that contains only one configuration file stored on the root directory of the stick into the USB port on the front panel of the controller. Press the Enter key to import the configuration file from the stick to the controller. The file name must have an ini extension in its name.	
	The controller will display the progress of the file import process. If the file was successfully imported from the USB disk the controller will display one of the messages below:	
	<b>Import Failure</b>	Indicates that there were problems connecting to or accessing the USB stick.
	<b>Import Success: Any key to reboot</b>	The configuration file import succeeded and will be ready for use after reboot.
	<b>File Open Failed</b>	A config file could not be found on the USB stick or the USB stick file system could not be accessed.
	<b>File Read Failed</b>	The config file is too short (incomplete) or empty.
	<b>Invalid CFG File</b>	The imported file is not a valid config file.
	<b>Invalid Model</b>	The imported config file is not for this controller model.
	<b>Wrong SW Version</b>	The version of the imported config file is not compatible with this controller software version.
	<b>Corrupt CFG File</b>	The imported config file is corrupt. (The checksum failed.)
<b>Wrong file Size</b>	The size of the imported config file is wrong.	



**Figure 14 Config Menu**

## 5.9 Upgrade Menu

This menu is used to upgrade the software to a newer version. If a new version of the software is available, an upgrade file will be posted on our web site. Save this file to a USB flash disk drive. It needs to be the only upgrade file stored on the root directory of the stick. Press the Enter key to import the software upgrade file from the stick to the controller.

The controller will display the progress of the file import process. If the file was successfully imported from the USB disk the controller will display Transfer Success. The controller will automatically reboot and come up with the new software installed.

<b>Upgrade</b>	<p>The controller will display the progress of the file import process. If the file was successfully imported from the USB disk the controller will display Transfer Success. The controller will automatically reboot and come up with the new software installed.</p> <p>If the software upgrade fails, you will see one of the following messages:</p> <table border="1"> <tr> <td data-bbox="565 646 818 730"><b>UpgradFileInvalid</b></td> <td data-bbox="818 646 1469 730">The file found on the USB stick is for the wrong product, or is corrupt. Try getting the correct upgrade file and make sure it's the only upgrade file on the stick.</td> </tr> <tr> <td data-bbox="565 730 818 800"><b>No Upgrade File</b></td> <td data-bbox="818 730 1469 800">There is no upgrade file stored on the stick, or the file is named incorrectly.</td> </tr> <tr> <td data-bbox="565 800 818 848"><b>CorrptUpgradFile</b></td> <td data-bbox="818 800 1469 848">Try getting a new copy of the file.</td> </tr> <tr> <td data-bbox="565 848 818 911"><b>Flash Failure</b></td> <td data-bbox="818 848 1469 911">The flash memory on the processor board has a problem. Repair or replace the front panel assembly.</td> </tr> </table>	<b>UpgradFileInvalid</b>	The file found on the USB stick is for the wrong product, or is corrupt. Try getting the correct upgrade file and make sure it's the only upgrade file on the stick.	<b>No Upgrade File</b>	There is no upgrade file stored on the stick, or the file is named incorrectly.	<b>CorrptUpgradFile</b>	Try getting a new copy of the file.	<b>Flash Failure</b>	The flash memory on the processor board has a problem. Repair or replace the front panel assembly.
<b>UpgradFileInvalid</b>	The file found on the USB stick is for the wrong product, or is corrupt. Try getting the correct upgrade file and make sure it's the only upgrade file on the stick.								
<b>No Upgrade File</b>	There is no upgrade file stored on the stick, or the file is named incorrectly.								
<b>CorrptUpgradFile</b>	Try getting a new copy of the file.								
<b>Flash Failure</b>	The flash memory on the processor board has a problem. Repair or replace the front panel assembly.								

To check that it was successful, turn off power to the controller, then press the Enter key while turning power on. The controller will show the software version, which should match the name of the upgrade file that you used.

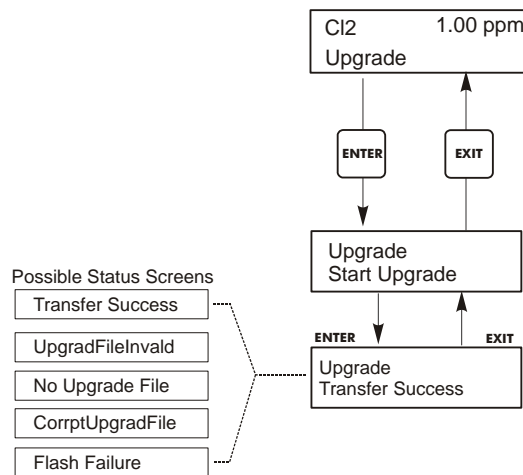

**Figure 15 Upgrade Menu**

## 6.0 Maintenance

---

The WDIS control module itself needs very little maintenance. Clean the outside of the controller enclosure with a damp cloth. Do not spray down the controller unless the enclosure door is closed and latched. "Pigtails" should be protected from spray or wash-down. Check the cords and cables for damage.

### 6.1 Sensor Maintenance

#### *Cleaning the Membrane*

Instructions for cleaning the membrane vary depending upon the type of contamination. Follow the directions for replacing the membrane shown below, replacing step 3 with one of these cleaning methods:

For general deposits:  
Rinse in clear cold water.

For calcium scale:  
Soak in dilute (1% by volume) hydrochloric acid, then rinse in clear cold water.

For oils:  
Rinse in isopropyl alcohol.  
DO NOT use cleaners or detergents containing surfactants, as these will reduce the life of the membrane.

If the sensor still cannot be calibrated after cleaning, replace the membrane cap as described below.

#### *Replacing the Membrane*



**CAUTION:** Wear gloves and safety glasses during assembly of the sensor since the electrolyte is a **STRONG ACID**. It is recommended to perform this operation over a sink with running water available. After using, re-cap any remaining electrolyte until the next use.

1. Hold the sensor vertically with the membrane facing down and carefully unscrew the membrane cap. Always move the gray bands to uncover the vent hole before removing the cap!
2. Rinse the electrolyte fill solution off the cap and electrodes with cold water.
3. Discard the old membrane cap.
4. Unpack the new membrane cap, taking care not to touch the membrane or get it dirty.
5. Fill the membrane cap to the top with the electrolyte fill solution.
6. Hold the sensor body vertically with the tip pointing down and **SLOWLY** screw on the membrane cap until it is hand tight. **Be prepared for some electrolyte solution to squeeze out from the cap**
7. Rinse your hands, the sensor, and all surfaces contaminated with electrolyte solution with running water.
8. Check the sensor for leaks, especially at the membrane and the membrane cap threads. If any leaks are detected, tighten the membrane cap or replace it.

## 6.2 Replacing the Fuses



**CAUTION:** Disconnect power to the controller before opening front panel!

Locate the fuses on the circuit board at the back of the controller enclosure. (See figure 4.) Gently remove the old fuse from its retaining clip and discard. Press the new fuse into the clip, secure the front panel of the controller and return power to the unit.

**Warning:** Use of non-approved fuses can affect product safety approvals. Fuse ratings depend on controller power rating. Specifications are shown below. To insure product safety certifications are maintained, it is recommended that a Walchem fuse be used.

F1 Fuse	Walchem P/N	F2 Fuse	Walchem P/N
5 x 20 mm, 1.0A, 250V	103163	5 x 20 mm, 6A, 250V	102834

## 7.0 TROUBLESHOOTING



**CAUTION:** Disconnect power to the controller before opening front panel!

Troubleshooting and repair of a malfunctioning controller should only be attempted by qualified personnel using caution to ensure safety and limit unnecessary further damage. Contact the factory.

### 7.1 Error Messages

#### Cal Failed

The expected response is  $-100$  mV/ppm for  $Cl_2$ ,  $ClO_2$ , and Ozone, or  $-1$  mV/ppm for Peracetic Acid. The acceptable range is for  $-100$  mV (or  $-1$  mV for PAA) to equal 0.5 to 2.0 ppm. If the sensor response is outside the acceptable range, refer the sensor's instruction manual for troubleshooting.

#### Sens Low No Cal

The Calibrate menu will not allow a calibration if the concentration is too close to zero ppm. If the sensor input is above  $-5$  mV (approximately 0.05 ppm), this message will appear. If the actual concentration is actually higher, refer to the sensor's instruction manual for troubleshooting.

#### Probe Error No Cal

The Calibration menus will reject the calibration if the sensor is in a Probe Error condition. Refer to the troubleshooting for Probe Error below.

#### Bad Zero Cal Fail

The Zero Calibration will fail if the mV reading from the sensor is outside of the range  $-100$  to  $100$  mV. If the actual concentration is actually zero, refer to the sensor's instruction manual for troubleshooting.

## Output Timeout

This error message appears if one of the control outputs has been on longer than the maximum amount of time programmed in the "Time Limit" menu found in the Control 1-4 menus. It is reset by answering "Yes" to the "Reset Timer" prompt that will appear. There are a number of possible reasons that the output could go on for longer than normal:

Possible Causes	Corrective Action
The process went further out of control than normal.	Increase time limit or reset timer.
The chemical supply has run out.	Replenish the chemical supply.
The pump or valve or supply line is faulty.	Repair or replace the control device.
Wrong chemical is being controlled.	Replace with correct chemical.
The sensor is not responding to changes.	Repair or replace sensor or cable. Refer to sensor instructions. Evaluate mixing or recirculation.

## High Alarm

This error message appears if the ppm reading exceeds the set point for one of the Control outputs that has been configured as a high alarm output. There are a number of possible causes for this condition:

Possible Cause	Corrective Action
The process went further out of control than normal.	May have to increase chemical flow rate.
The chemical supply has run out.	Replenish the chemical supply.
The pump or valve or supply line is faulty.	Repair or replace the control device.
Wrong chemical is being controlled.	Replace with correct chemical.
The sensor is not responding to changes.	Replace sensor or cable. Evaluate mixing or recirculation.
The pump is siphoning, valve leaking.	Repair or replace the control device or re-route tubing.
Control output has been left in "HAND" mode.	Switch back to "AUTO".
It may be a normal part of the process.	None required.

## Probe Error

This error message appears if the sensor input signal is outside of the normal range. This usually indicates that the sensor has been disconnected or is faulty. It could appear under normal conditions if the ppm is outside of the operating range of 0-20 (or 2000 if Peracetic acid).

Possible Cause	Corrective Action
Controller is faulty; fails self test (see section 5.2)	Re-check self test with sensor disconnected. If it still fails, send controller back for repair. If it passes, sensor is faulty.
Sensor has no power to it.	If battery powered preamp, replace battery. If preamp is powered by our controller, check +5V, -5V terminals vs COM terminal. Should read +5VDC $\pm 5\%$ and -4.6 VDC $\pm 5\%$ .
Sensor is faulty.	Indicated if $\pm 5$ VDC power out of spec w/sensor attached, but in spec without sensor attached. Replace sensor.
Sensor is faulty.	Replace sensor.

## Interlock

This error message indicates that control has been stopped because the closed contact signal from a flow switch or level switch is now open and one or more control outputs have been programmed to interlock.

Possible Cause	Corrective Action
Flow has stopped, level too low.	May be a normal condition, otherwise restore flow or level.
Flow, level switch disconnected.	Reconnect.
Flow, level switch faulty.	Verify that switch closes using an ohmmeter. If not, repair or replace.
Controller faulty.	Verify that error message disappears if controller flow switch input is shorted. If not, repair controller.

### Calibration Time

This message appears to prompt you to perform the routine maintenance of cleaning and calibrating the sensor. It does not appear based upon any analysis of the condition of the sensor. The frequency of calibration is set by the user in the "Days Between Cal" menu found in the "Sensor" menu. If you do not want to be prompted to perform a calibration, set this menu to "0".

### Low Alarm

As above for "High Alarm", except that the reading is below the set point of one of the Control outputs that has been set up as a low alarm output. Refer to the possible causes and corrective actions listed above for the "High Alarm" error message.

### Out Range Alarm

This error message appears if the ppm reading is outside of the range selected for one of the Control outputs that has been programmed as an "Out of Range Alarm". Refer to the possible causes and corrective actions listed above for the "High Alarm" error message.

### In Range Output

This error message appears if the ppm reading is inside of the range selected for one of the Control outputs that has been programmed as an "In Range Alarm". Refer to the possible causes and corrective actions listed above for the "High Alarm" error message.

### Check Set Points

This is a normal display if you have changed the choice of sensor type in the Sensor menu. The default set points for each choice could be different, and will not match what you need for your application. Always select the sensor type before setting the control output set points.

## 8.0 SERVICE POLICY

---

The WDIS Series Disinfection Controller has a 2-year warranty on electronic components and a 1-year warranty on mechanical parts (keypad, terminal strip and relays).

We stock circuit boards for immediate exchange after we have isolated the cause of the problem.

Factory authorized repairs that are received by next-day-air will be returned within 24 hours. Normal priority for returns is two weeks.

Out of warranty repairs or circuit board exchanges are done on a flat fee basis after the warranty is expired.