



EWN-R Series Electromagnetic Metering Pumps

The EWN-R Series electronic metering pumps offer superior high speed dosing capability with more standard features. The flexibility of the EWN-R pump enable it be integrated into virtually any chemical feed application using a universal-voltage, digital controller with an expanded set of control features. Superb valve performance and advanced solenoid engineering combine to make a highly precise pump for the most demanding applications.

EWN pumps have outputs to 6.7 GPH (25.2 L/h) and a maximum pressure of 250 PSI (17 bar). The high speed of operation results in high resolution chemical feed and long service life. Quiet and compact, the EWN pump prime in seconds and hold prime reliably.



➤ High Speed Performance

E-Series pumps operate up to 360 strokes-per-minute with adjustments in 1 spm increments, providing high resolution chemical feed. Adjustable stroke length further increases the ability to refine output, making the E-Series one of the most versatile solenoid metering pumps on the market.

➤ Multi-function Digital Controller

The controller in the EWN-R pump provides for flexible pump control including scalable Analog control, Digital Input with both Multiply and Divide capability, external stop control, or simple speed and stroke length control. Display can be adjusted between flow rate units or % speed for easy-to-read output and quick adjustment. The controller is universal voltage so it can be used anywhere in the world.

➤ Engineered Longevity

All E-Series pumps feature dual bearing support. The armature and shaft are supported with a bearing on each end, which ensures proper axial movement, enabling the E-Series to operate at 360 SPM while extending the life of the diaphragm.

➤ Superior Check Valve Performance

Dual Check Valve Assemblies in both suction and discharge fittings feature precision ball guides and tapered seats. Precise machining and molding of parts limit valve ball travel, ensuring that balls fully seat and seal with every stroke. This superior check valve design guarantees fast priming and reliable performance.

➤ Flexible Connections

A removable tubing insert provides flexibility of tubing sizes and eliminates twisting of the tubing during connection. A threaded insert can be used in place of the tubing adapter to easily convert any connection to NPT.



➤ High Compression Ratio

The compression ratio of a metering pump is important because it affects the pump's ability to prime and vent. The compression ratio is raised when you reduce the dead volume of the pump head during operation. All E-Series pumps feature a very high compression ratio that ensures proper feed especially with off-gassing products (i.e. Sodium Hypochlorite).

Specifications

Model Identification

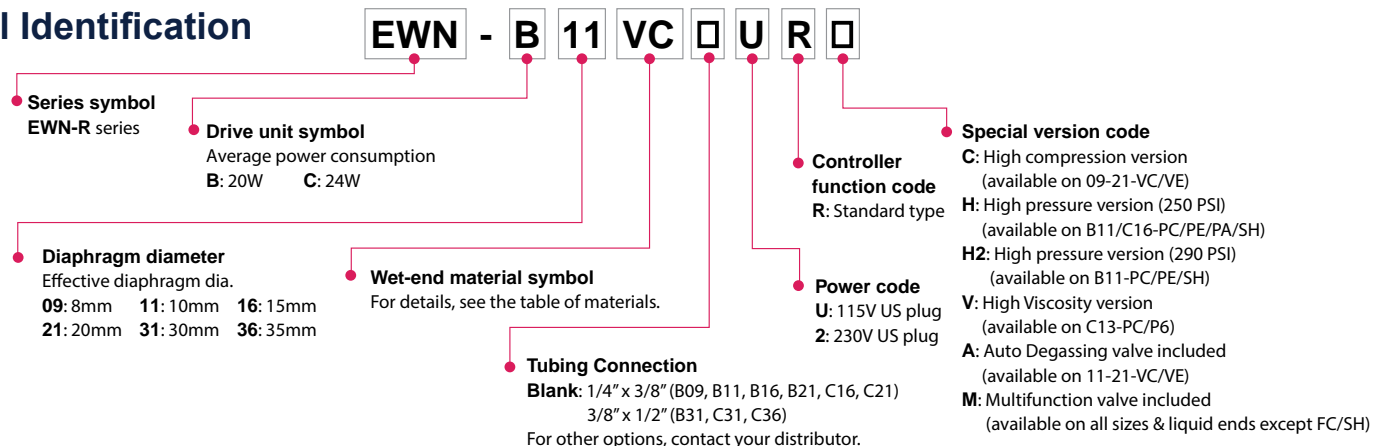

Wet End Materials

	Pump Head	Diaphragm	Valve Balls	Valve Seat	O-ring Seal	Gasket
VC	PVC	PTFE + EPDM	CE	FKM	FKM	PTFE
VE				EPDM	EPDM	
VF			PTFE	EPDM	EPDM	
PC	CE			FKM	FKM	
PE			EPDM	EPDM		
PA			PCTFE	AFLAS®		
FC			PCTFE	PTFE		
TC	PVDF		FKM	FKM		
TA			PCTFE	AFLAS®		
SH(N)	SUS316		HC	SUS316	PTFE	

CE Alumina ceramic EPDM Ethylene propylene diene monomer
 FKM Fluoroelastomer GFRPP Glass fiber reinforced polypropylene
 PTFE Polytetrafluoroethylene PVC Polyvinylchloride (translucent)
 PCTFE Polychlorotrifluoroethylene HC Hastelloy C276
 PVDF Polyvinylidene fluoride

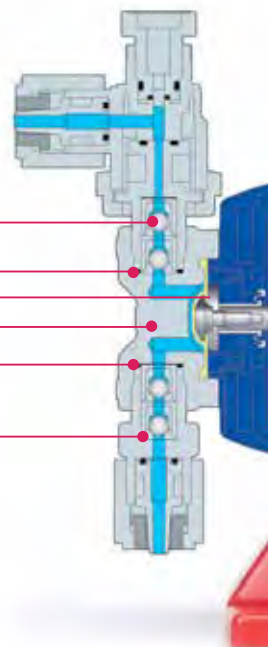

Pump Specifications (Standard pumps and pumps with MFV)

Model		B11	B16	B21	B31	C16	C21	C31	C36	
									VC/VE/PC/PE	FC/SH/TC
Max. Output Capacity	GPH	0.6	1.0	1.6	3.2	1.3	2.1	4.3	6.7	6.5
	mL/min	38	65	100	200	80	130	270	420	410
	mL/shot	0.02-0.11	0.04-0.18	0.06-0.28	0.11-0.56	0.04-0.22	0.07-0.36	0.15-0.75	0.23-1.17	0.23-1.14
Rated discharge pressure	PSI	150	105	60	30	150	105	50	30	30
Max pressure	PSI	203	116	73	30	174	116	50	30	30
Stroke rate	% (spm)	0.1 to 100 (1 to 360)								
Stroke length rate	% (mm)	20 to 100 (0.2 to 1.0)				20 to 100 (0.25 to 1.25)				

Note 1: Max. output capacity shown is at **Rated Discharge Pressure** (stroke length 100%, stroke rate 100%) and increases as a discharge pressure reduces.

Note 2: Max pressure rating is the maximum useable capability of the pump. Max. output capacities may be lower than published at pressures higher than Rated Discharge Pressure. Max. pressure of PVC type is 174 PSI. Please contact your distributor for more information.

Note 3: The performance is based on pumping clean water at ambient temperature at rated discharge pressure and voltage.

Note 4: Liquid temperature: PVC liquid ends: 14 to 104°F (-10 to 40°C) GRFPP/PVDF/SS liquid ends: 14 to 140°F (-10 to 60°C)

Note 5: Ambient temperature: 32 to 122°F (0 to 50°C) Relative humidity: to 85% (non-condensing)

Input/Output Connectors (Sold Separately):

E90495 5-pin connector: Use for Analog, Pulse & AUX inputs + Output Relay on EWN-R

E90496 5-pin reverse key connector: Use for Stop & Pre-Stop inputs on EWN-R

Specifications

Controller Specifications

Operational mode	MAN	0.1 to 100% stroke rate	
	EXT control	DIV (Dividing)	/1 to 0000
		MULT (Multiply)	x1 to 9999
		ANA. R (Analog, rigid)	4 to 20, 0 to 20, 20 to 4, 20 to 0 mA
	ANA. V (Analog, variable)	2 points 0.0 to 20.0 mA range 0.0 to 100% stroke rate	
Display	LCD	14 segment 5 digits	% , ml/m, L/H, GPH, STOP, PRIME, AUX etc
	LED	ON	Green Green lights when ON blinks OFF synchronous with stroke.
		STOP	Orange/Red Orange lights when Pre-STOP is made, red when STOP is made.
Keypad	5 keys	START/STOP, EXT, ▲(UP), ▼(DOWN), Disp	
Control function	STOP/Pre-STOP	Pump keeps running when Pre-STOP is made. Pump stops when STOP is made.	
	Prime	Pump runs at max. stroke rate while up and down keys are pressed.	
	Key lock	Keypad can be locked and unlocked.	
	Calibration	Discharge capacity per shot is calculated automatically by operating and stopping pump in the calibration mode to determine the flow rate.	
	Buffer memory	ON or OFF selectable. Max. 65535 stroke pulses are stored in memory.	
Input	Pulse	No voltage contact or open collector. Max 200 Hz. NO/NC selectable	
	Current	DC0 - 20mA (Input resistance 200 Ω)	
	Stop/Pre-stop	No Voltage contact or open collector	
	AUX	Pump runs at max.stroke rate when made. No Voltage contact or open collector	
Output	Photo-MOS relay AC/DC24V 0.1A		
	STOP, Synchronous with stroke		

Note 1: If the max. stroke rate by calculation exceeds 100% stroke rate because of the relation between the setting and input signal when the pump is in EXT operation, the operation is fixed at Maximum stroke rate speed of manual operation.

Note 2: By changing the setting, the pump can run when the contact signal comes in. **Note 3:** The max. frequency of input pulse is 200 Hz. ON time of input pulse is 10 to 100 mS.

Note 4: The max. potential voltage at a contact is 12V and current is 0.1mA. If a contact such as relay is used, the minimum application load should be 0.1mA or less.

Safety Certifications

The EWN series metering pumps* are WQA tested and certified to NSF/ANSI Standard 50 and Standard 61.

* See www.wqa.org for specific chemicals and certification parameters.



The EWN series metering pumps are tested by Intertek to UL and CSA standards.



Electrical Specifications

EWN	EWN-B	EWN-C
50/60 Hz, 1 phase	20 Watt avg.	24 Watt avg.
100-240VAC ±10%	0.8 Amp max.	1.2 Amp max.

Shipping weight

EWN-B: 10 lbs (4.5 kg)

EWN-C: 12 lbs (5.5 kg)

Dimensions (in inches)

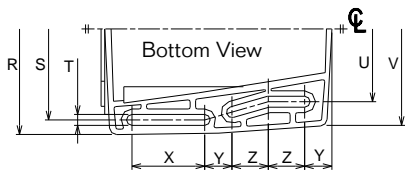
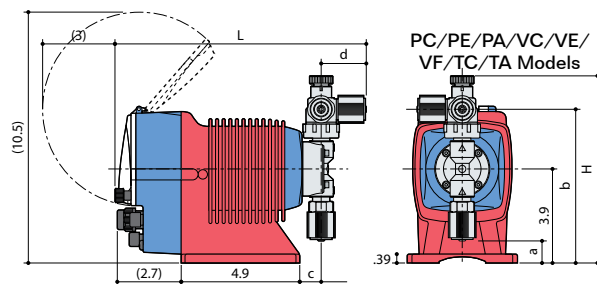

Material	Model	H	L	a	b	c	d
PC/PE/PA VC/VE/VF TC/TA	EWN-11, 16, 21	7.83	10.43	0.94	6.45	0.90	1.85
	EWN-31	8.34	10.51	0.23	6.97	0.98	1.89
	EWN-36	8.30	10.51	0.27	6.93	0.94	1.89
SH	EWN-11, 16, 21	7.91	9.13	1.73	6.10	0.86	0.59
	EWN-31	8.38	9.17	1.34	6.49	0.90	0.59
	EWN-36	8.50	9.17	1.26	6.69	0.90	0.59
FC	EWN-11, 16, 21	6.53	9.09	1.57	6.31	0.90	0.51
	EWN-31	6.97	9.29	0.90	6.97	0.98	0.63
	EWN-36	6.97	9.25	0.90	6.97	0.94	0.63

Mounting Dimensions

EW Model	R	S	T	U	V	X	Y	Z
11, 16, 21	4.57	3.94	0.24	3.15	4.17	1.57	0.59	0.79
31, 36								

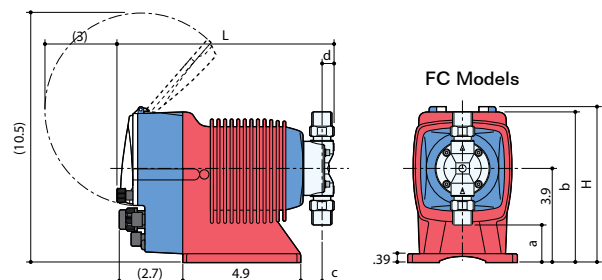
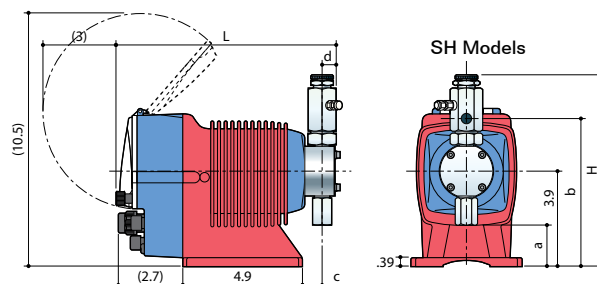

Construction

Auto Degassing Valve Model

Chemicals that outgas, such as Sodium Hypochlorite or Hydrogen Peroxide, can generate enough gas to gas lock metering pumps. Using a dual check valve system, the Auto Degassing Valve vents any gas to atmosphere to eliminate gas lock conditions and keep the pump primed.

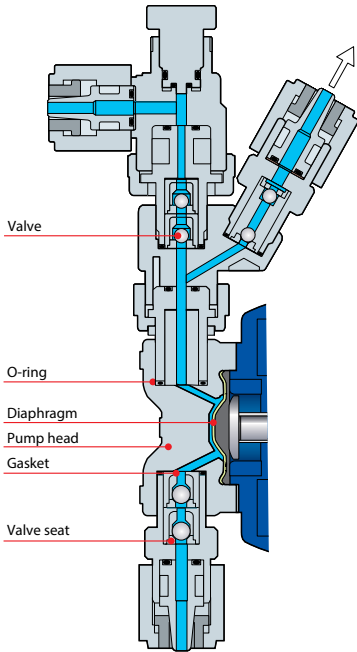

High Compression Model

Increasing the compression ratio by minimizing dead volume in the liquid end further helps to eliminate gas in the pump heads. In addition to reducing air lock conditions, the increased compression ratio helps with accuracy at low output ranges.

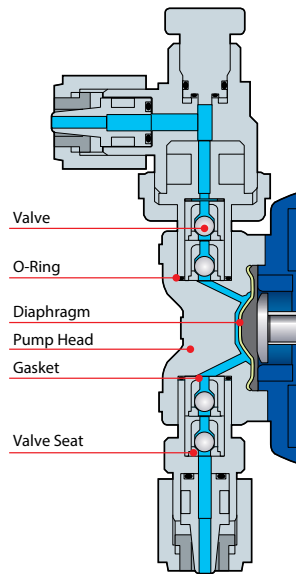

High Pressure Model

The high pressure model is capable of operating at flow rates of 0.4 or 0.6GPH (25 or 40mL/min) at a maximum discharge pressure up to 250PSI. This makes it suitable for applications such as chemical injection into boiler makeup water.

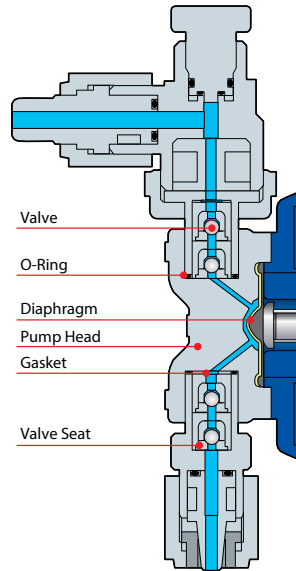

High Viscosity Model

The High Viscosity pump has a uniquely designed liquid end with oversized flow paths and spring loaded valve checks. Coupled with a reduced max speed, the HV pumps are designed for polymer/coagulant injection in water treatment applications.

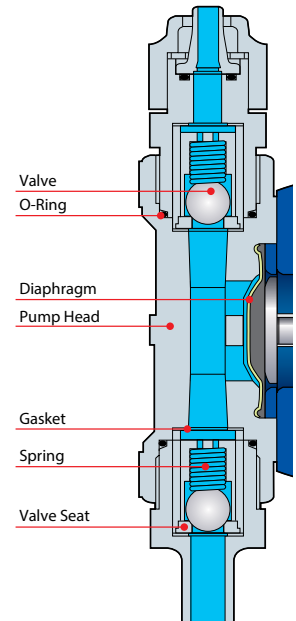

Wet-end material

Material code	VC-A	VE-A
Pump head	PVC	
Valve	CE	
Valve seat	FKM	EPDM
Gasket	PTFE	
O-ring	FKM	EPDM
Diaphragm	PTFE+EPDM	

Wet-end material

Material code	VC-C	VE-C
Pump head	PVC	
Valve	CE	
Valve seat	FKM	EPDM
Gasket	PTFE	
O-ring	FKM	EPDM
Diaphragm	PTFE+EPDM	

Wet-end material

Material code	PC-H	PE-H	SH-H
Pump head	GFRPP	SUS316	
Valve	CE	HC	
Valve seat	FKM	EPDM	SUS316
Gasket	PTFE		
O-ring	FKM	EPDM	—
Diaphragm	PTFE+EPDM		

Wet-end material

Material code	PC-V	P6-V
Pump head	GFRPP	
Valve	CE	316 SS
Valve seat	PCTFE	
Spring	Hastelloy C276	316 SS
Gasket	PTFE	
O-ring	FKM	EPDM
Diaphragm	PTFE+EPDM	

Specifications (Special versions)

Model	Auto Degassing Valve					High Compression Models						
	B11	B16	B21	C16	C21	B09	B11	B16	B21	C16	C21	
Max. Output Capacity	GPH	0.5	0.9	1.4	1.0	1.7	0.2	0.4	0.6	1.0	0.9	1.2
	mL/min	30	55	86	65	110	12	23	40	63	54	78
	mL/shot	0.02 - 0.08	0.03 - 0.15	0.05 - 0.24	0.04 - 0.18	0.06 - 0.31	0.01 - 0.07	0.03 - 0.13	0.04 - 0.22	0.07 - 0.35	0.06 - 0.30	0.09 - 0.43
Rated Discharge Pressure	PSI	150	105	60	150	105	150	150	105	60	150	105
Stroke Rate	% (spm)	0.1 - 100 (1-360)					0.1 - 100 (1-180)					
Stroke Length Range	% (mm)	20 - 100 (0.2 - 1.0)			20 - 100 (0.25 - 1.25)		20 - 100 (0.25 - 1.25)			20 - 100 (0.3 - 1.50)		

Model	High Pressure Models		High Pressure Models (290 psi)	High Viscosity Models
	B11	C16	B11	C31
Max. Output Capacity	GPH	0.4	0.6	2.4
	mL/min	25	40	150
	mL/shot	0.02 - 0.1	0.03 - 0.17	0.13 - 0.63
Rated Discharge Pressure	PSI	250	250	73
Stroke Rate	% (spm)	0.1 - 100 (1-240)		0.1 - 100 (1-240)
Stroke Length Range	% (mm)	20 - 100 (0.2 - 1.0)	20 - 100 (0.25 - 1.25)	20 - 100 (0.25 - 1.25)

Note 1: Max. output capacity shown is at **Rated Discharge Pressure** (stroke length 100%, stroke rate 100%) and increases as a discharge pressure reduces.
 Note 2: The performance is based on pumping clean water at ambient temperature at rated voltage.