WebAlert Series

Process Monitor

Instruction Manual 

W A L C H E M

Notice

© 2005 WALCHEM Corporation
Five Boynton Road, Holliston, MA 01746 USA
(508) 429-1110
All Rights Reserved
Printed in USA

Proprietary Material

The information and descriptions contained herein are the property of WALCHEM Corporation. Such information and descriptions may not be copied or reproduced by any means, or disseminated or distributed without the express prior written permission of WALCHEM Corporation, Five Boynton Road, Holliston, MA 01746.

Statement of Limited Warranty

WALCHEM Corporation warrants equipment of its manufacture, and bearing its identification to be free from defects in workmanship and material for a period of 24 months for electronics and 12 months for mechanical parts from date of delivery from the factory or authorized distributor under normal use and service and otherwise when such equipment is used in accordance with instructions furnished by WALCHEM Corporation and for the purposes disclosed in writing at the time of purchase, if any. WALCHEM Corporation's liability under this warranty shall be limited to replacement or repair, F.O.B. Holliston, MA U.S.A. of any defective equipment or part which, having been returned to WALCHEM Corporation, transportation charges prepaid, has been inspected and determined by WALCHEM Corporation to be defective. Replacement elastomeric parts and glass components are expendable and are not covered by any warranty.

THIS WARRANTY IS IN LIEU OF ANY OTHER WARRANTY, EITHER EXPRESS OR IMPLIED, AS TO DESCRIPTION, QUALITY, MERCHANTABILITY, and FITNESS FOR ANY PARTICULAR PURPOSE OR USE, OR ANY OTHER MATTER.

*180188 Rev D3
August 2005*

TABLE OF CONTENTS



1.0	INTRODUCTION	1
2.0	SPECIFICATIONS	2
2.1	MEASUREMENT PERFORMANCE	2
2.2	ELECTRICAL	2
2.3	MECHANICAL	3
2.4	VARIABLES AND THEIR LIMITS	3
3.0	UNPACKING & INSTALLATION	4
3.1	UNPACKING THE UNIT	4
3.2	MOUNTING THE ELECTRONIC ENCLOSURE	4
3.3	INSTALLATION	5
3.4	ICON DEFINITIONS	5
3.5	ELECTRICAL INSTALLATION	5
4.0	FUNCTION OVERVIEW	11
4.1	FRONT PANEL	11
4.2	INITIAL STARTUP	11
4.3	COMMUNICATING WITH THE WEBALERT	13
4.4	STARTUP	19
4.5	SHUT DOWN	19
5.0	OPERATION	19
5.1	MENU SELECTION LINKS	19
5.2	STARTUP	20
5.3	SYSTEM SUMMARY MENU	21
5.4	4-20 MA INPUTS	21
5.5	4-20 MA CALIBRATION	24
5.6	DIGITAL INPUTS	24
5.7	ALARM	28
5.8	DATA LOGGING	29
5.9	AUTO REPORTING	30
5.10	GRAPHING/TRENDING	32
5.11	COMMUNICATIONS	32
5.12	ADVANCED COMMS	36
5.13	SOFTWARE UPGRADE	37
5.14	CONFIGURATION FILE	38
5.15	NOTEPAD	38
5.16	ACCESS CODES	38
5.17	WEBALERT HELP	39
5.18	WALCHEM HOME PAGE	39
5.19	SUB-NETWORK	39
6.0	MAINTENANCE	40
6.1	REPLACING THE FUSES	40
7.0	TROUBLESHOOTING	41
7.1	ERROR MESSAGES	41
8.0	SERVICE POLICY	44

1.0 INTRODUCTION



WebAlert is the first stand alone remote monitoring device that can web enable your installed equipment without having to replace or upgrade it. Your key system parameters (analog and digital input signals) can now be monitored from any computer – anywhere in the world - with a standard web browser.

With proprietary on-demand connectivity, the WebAlert is only online when you need it...making it the world's first practical and secure industrial monitoring Internet solution.

WebAlert pulls your older equipment into the Internet age with online monitoring, data logging, auto reporting and auto alarming. User defined alarms can be received by email or page. The solid state alarm relay notifies on-site personnel.

Data logs can be delivered by email as a spreadsheet attachment. You decide where and when you need the information and WebAlert makes it happen. Since WebAlert supports simultaneous multi-user access and Ethernet, all of its remote monitoring features are also available on local area networks (LAN). For larger installations, which require more than six analog and two digital inputs, WebAlerts can be networked together with Ethernet.

In addition, settings and data may be manipulated using a computer connected directly via RS232, or modem to modem without requiring an Internet connection.

2.0 SPECIFICATIONS

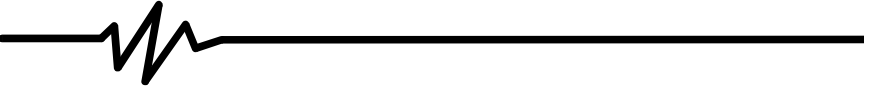

2.1 Measurement Performance

4-20 mA Inputs

Range	3.75-20.25 mA
Resolution	0.03 mA
Calibration	± 1 mA

2.2 Electrical

Inputs

Input power 100 – 120/220-240 VAC ±10%, 1.0A, 50/60 Hz **Fuse** 1.0A, 5 x 20mm

Input signals

Analog Inputs (six)	4-20 mA, 2-wire or 3 -wire, internally powered by 24 VDC, 110 ohm input resistance, 1000 ohm maximum load.
Digital Inputs (two)	Isolated dry contact (relay, reed switch or Hall Effect) 0-10 Hz, 50 msec minimum width
Water meter Contactor:	Isolated dry contact (relay, reed switch or Hall Effect) 0-10 Hz ,50 msec minimum width
Paddlewheel Water Meter:	Isolated dry contact (relay, reed switch or Hall Effect) 0-400 Hz ,1.5 msec minimum width
Level Switch:	Isolated dry contact (relay, reed switch or Hall Effect)

Outputs

Solid State Relay: Dry Contact, 0 to 40 VDC, NO AC VOLTAGE, 150 mA maximum load
Digital: RS232

Agency Approvals

UL	UL 61010C-1:2000; IEC 61010-1:1990
CSA	CAN/CSA C22.2 No.1010.1:92; 1010.1B:97

2.3 Mechanical

Enclosure

Material:	Polycarbonate
NEMA Rating:	NEMA 4X (IP 66)
Dimensions:	18 cm x 22 cm x 9 cm (7" x 8.5" x 3.5")
Operating Ambient Temp:	0 to 60° C (32 to 140°F)
Storage Temp:	-29 to 80°C (-20 to 176 °F)
Weight	2.95 kg. (6.5 lbs)

2.4 Variables and their Limits

All menus shown may not be available. The menus that appear on your controller will vary with options installed and programmed.

Generic 4-20 mA Input Menu

4 mA =	-100,000 to 100,000 (units of measure defined by user)
20 mA =	-100,000 to 100,000 (units of measure defined by user)
Low Alarm Limit	-100,000 to 100,000 (units of measure defined by user)
High Alarm Limit	-100,000 to 100,000 (units of measure defined by user)

Level (4-20 mA) Input Menu

mA when Tank Empty	0 to 20 mA
mA when Tank Full	0 to 20 mA
Full Tank Volume	0 to 10,000 (units defined by user)
Low Alarm Limit	0.001 to 10,000 (units defined by user)

Flow Meter 4-20 mA Input Menu

4 mA =	0 to 100,000 (units of flow rate defined by user)
20 mA =	0 to 100,000 (units of flow rate defined by user)
Low Alarm Limit	0 to 100,000 (units of flow rate defined by user)
High Alarm Limit	0 to 100,000 (units of flow rate defined by user)
Total Limit	0 to 100,000 (units of total volume defined by user)

Digital Input Menu

Volume per Contact	0 to 1000 (units of measure defined by user)
K Factor	0.001 to 20,000 (Pulses per Gallon or Liter)
Total Alarm Limit	0 to 100,000 (units defined by user)
Rate Low Alarm	0 to 100,000 (units defined by user)
Rate High Alarm	0 to 100,000 (units defined by user)

Alarm Output Menu

Remote Alarm Delay Time	1 to 1440 minutes
Output Time Limit	0 to 1440 minutes (0 = infinity)
Alarm Hand Time Limit	1 to 1440 minutes

2.4 Variables and their Limits (continued)

Auto Reporting Menu

Frequency of Logging 10 to 1440 minutes

Access Code Menu

Session Timeout 0 to 60 minutes (0 = infinity)

3.0 UNPACKING & INSTALLATION

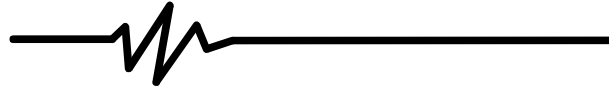

3.1 Unpacking the Unit

Inspect the contents of the carton. Please notify the carrier immediately if there are any signs of damage to the process monitor or its parts. Contact your distributor if any of the parts are missing. The carton should contain a WebAlert series process monitor and instruction manual. Any options or accessories will be incorporated as ordered.

3.2 Mounting the Electronic Enclosure

The WebAlert series process monitor is supplied with mounting holes on the enclosure. It should be wall mounted with the display at eye level on a vibration-free surface, utilizing all mounting holes for maximum stability.

The enclosure is NEMA 4X (IP66) rated, suitable for outdoor installation. The maximum ambient operating temperature is 140 degrees F (60 degrees C); this should be considered if installation is in a high temperature location.

The installation site should be in close proximity to grounded AC power, the devices to be connected, and phone line or Ethernet hub (if applicable).

Avoid locations that are in close proximity to sources of electrical noise (motor starters, power transformers, variable speed motor drives, radio transmitters, etc.), corrosive fumes or excessive moisture.

The enclosure requires the following clearances:







Top:	2"
Left:	4"
Right:	4"
Bottom:	4"

3.3 Installation

The WebAlert receives digital and analog input signals, and sends a digital output signal. The maximum distances for these cables, using 24 AWG shielded twisted pair cable, is 1200 meters (4000 feet) for the 4-20 mA input signals and 300 meters (1000 feet) for the digital input and output signals. It is highly recommended that these cables be routed separately from any AC voltage wires, and that the cable shield drain wire is connected to earth ground at the controller end only.

Note: Using the WebAlert controller in any manner other than that specified in this manual could compromise the safety of persons or property.

3.4 Icon Definitions

Symbol	Publication	Description
	IEC 417, No.5019	Protective Conductor Terminal
	IEC 417, No. 5007	On (Supply)
	IEC 417, No. 5008	Off (Supply)
	ISO 3864, No. B.3.6	Caution, risk of electric shock
	Pending	Caution, High temperature, risk of burn
	ISO 3864, No. B.3.1	Caution

3.5 Electrical Installation

The WebAlert series process monitors require the following voltages:
100 –120/200-240 VAC± 10%, 50/60 Hz, 1.0 amperes maximum.

Your unit is supplied either factory prewired or ready to be hardwired. Depending upon your choice of options, you may be required to hardwire some or all of the input/output devices. Please refer to Figures 2 through 5 for wiring diagrams.

Note: Proper grounding of this product is required. Any attempt to bypass the grounding will compromise the safety of persons and property.



CAUTION! There are live circuits inside the controller even when the power switch on the front panel is in the OFF position! The front panel must never be opened before power to the controller is REMOVED!

If your controller is prewired, it is supplied with an 8 foot, 18 AWG power cord with USA style plug. A tool (#1 Phillips screwdriver) is required to open the front panel.



CAUTION! The electrical installation of the controller must be done by trained personnel only and conform to all applicable National, State and Local codes!

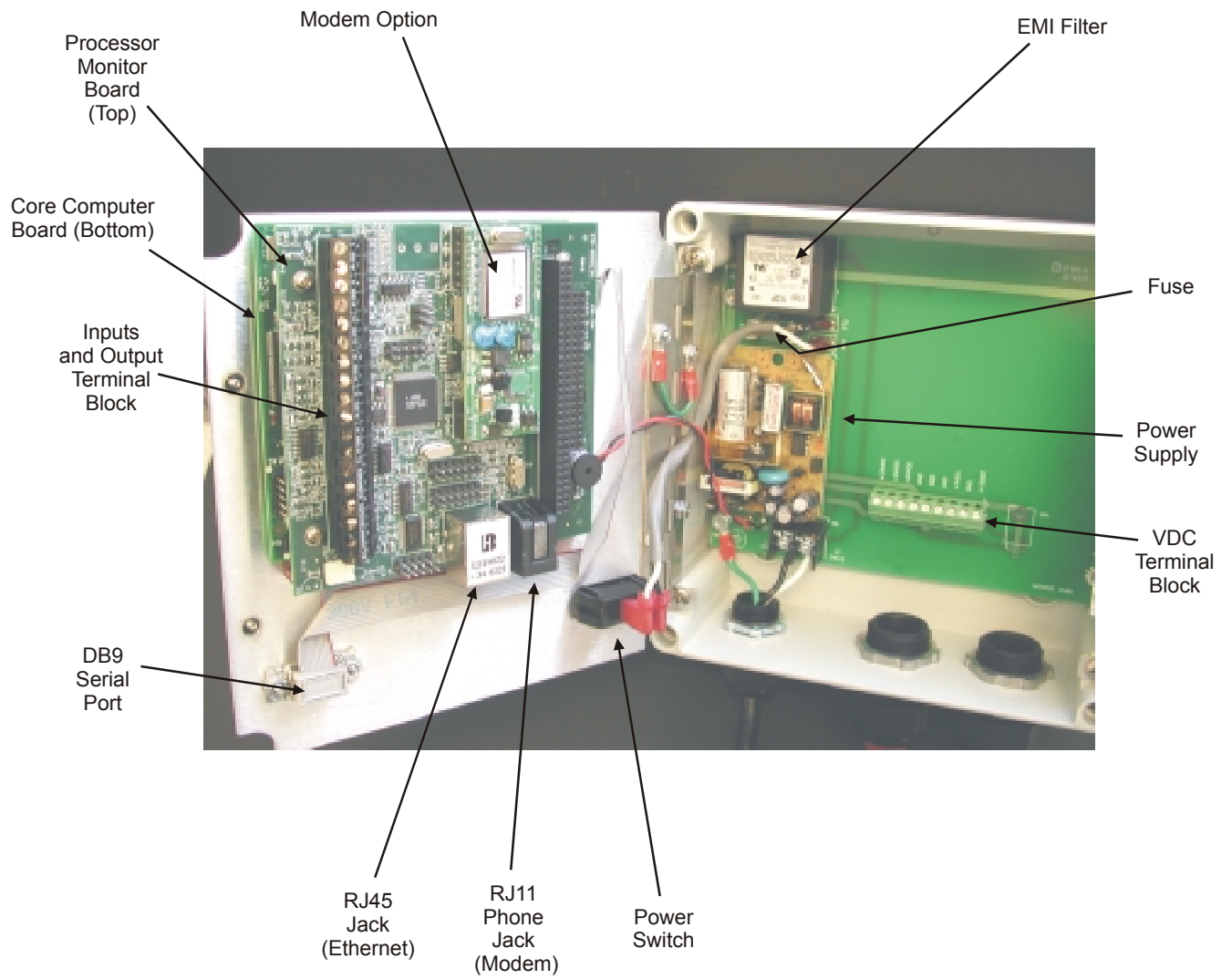
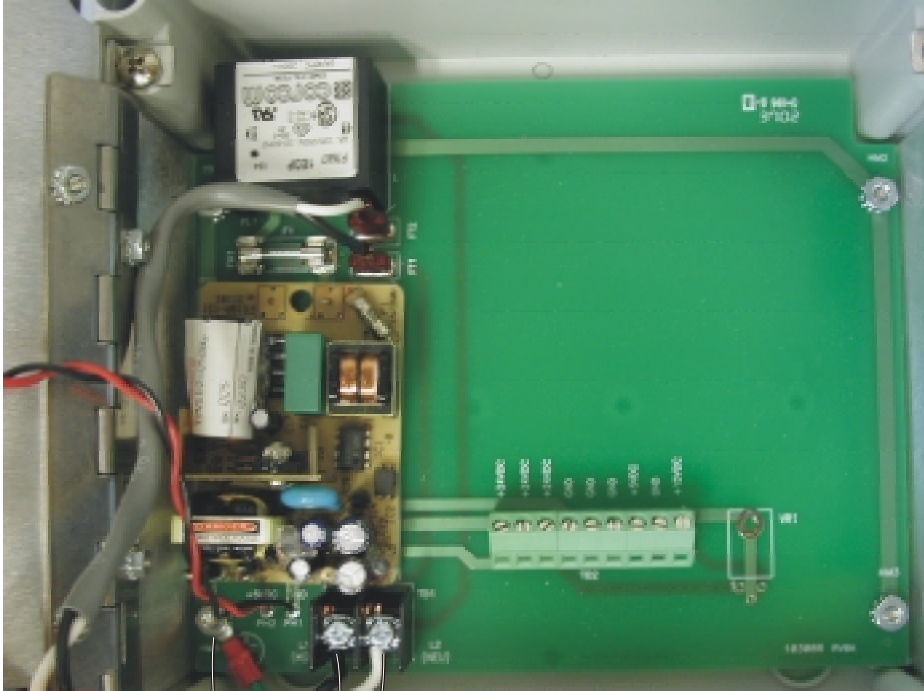

Figure 1 Identification of Parts



Earth
Ground

Hot

Neutral

Important: The Mains Power
supply earth ground connection
must be retained by a separate nut.

AC Power Input

Figure 2 – Wiring Diagram for AC Power Input

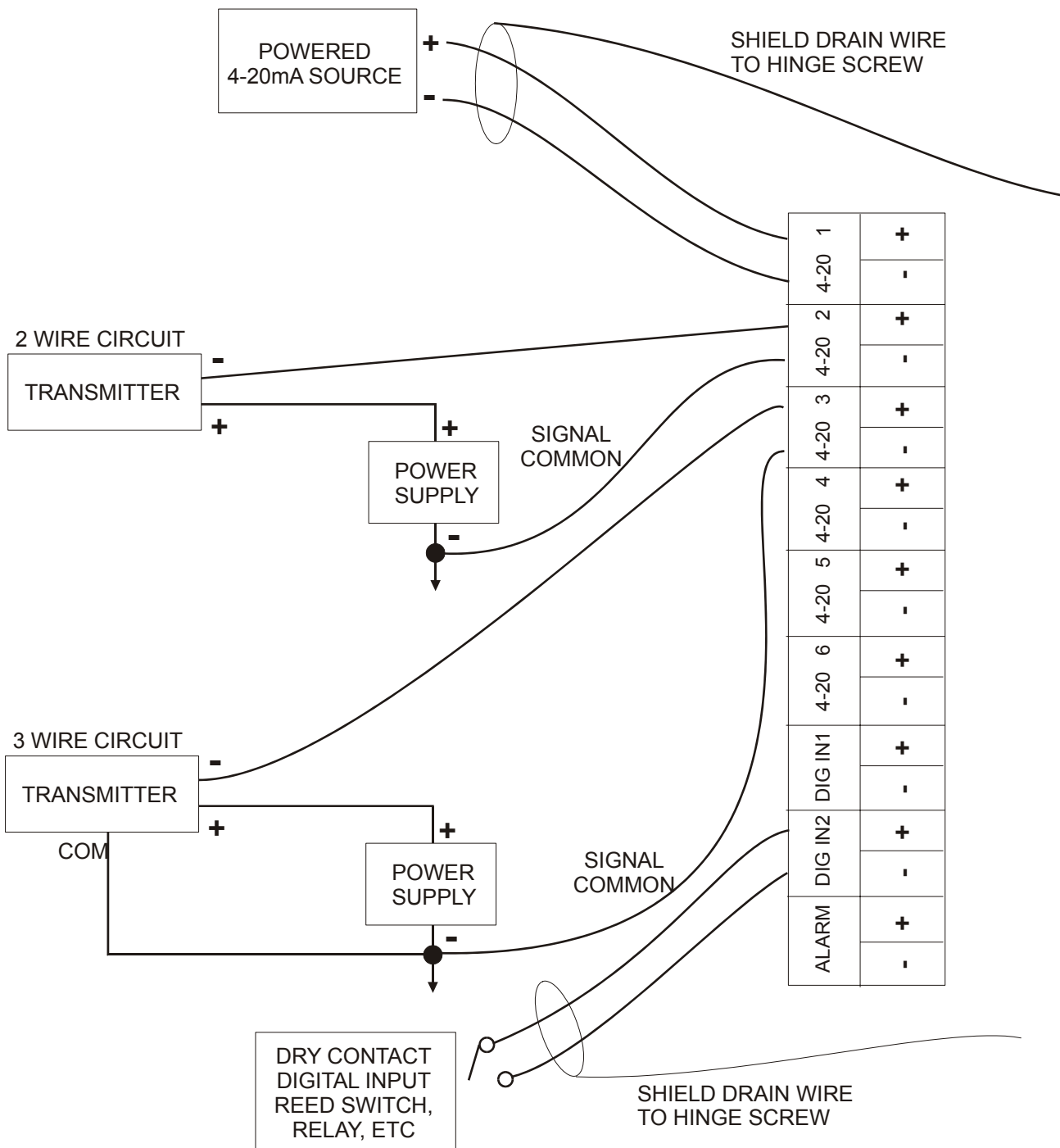
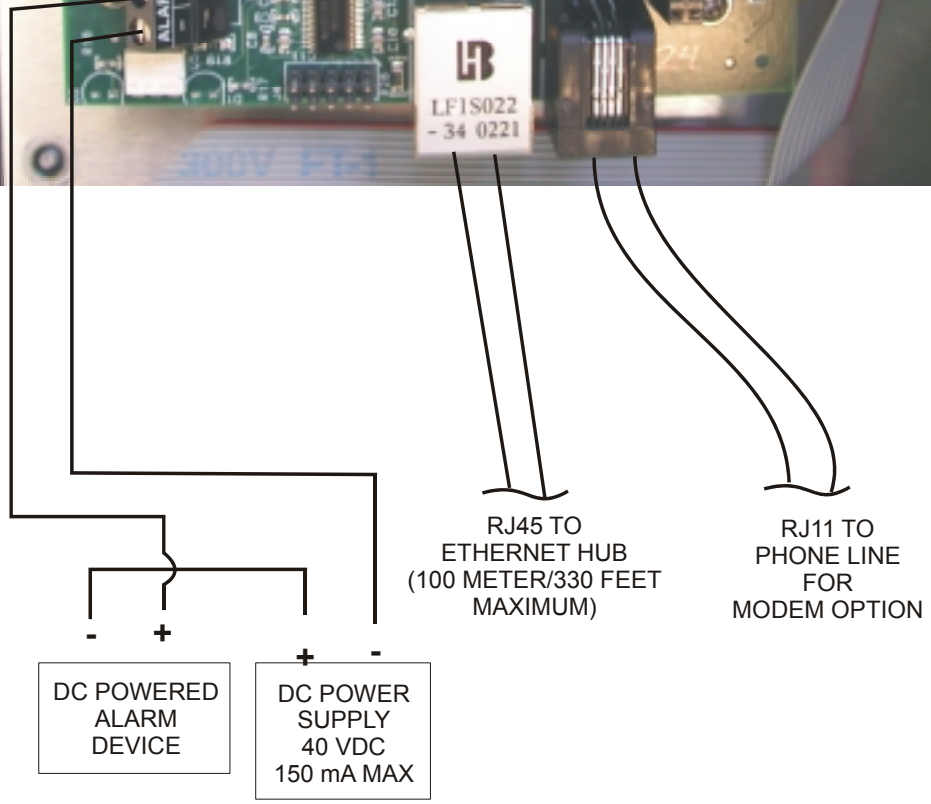
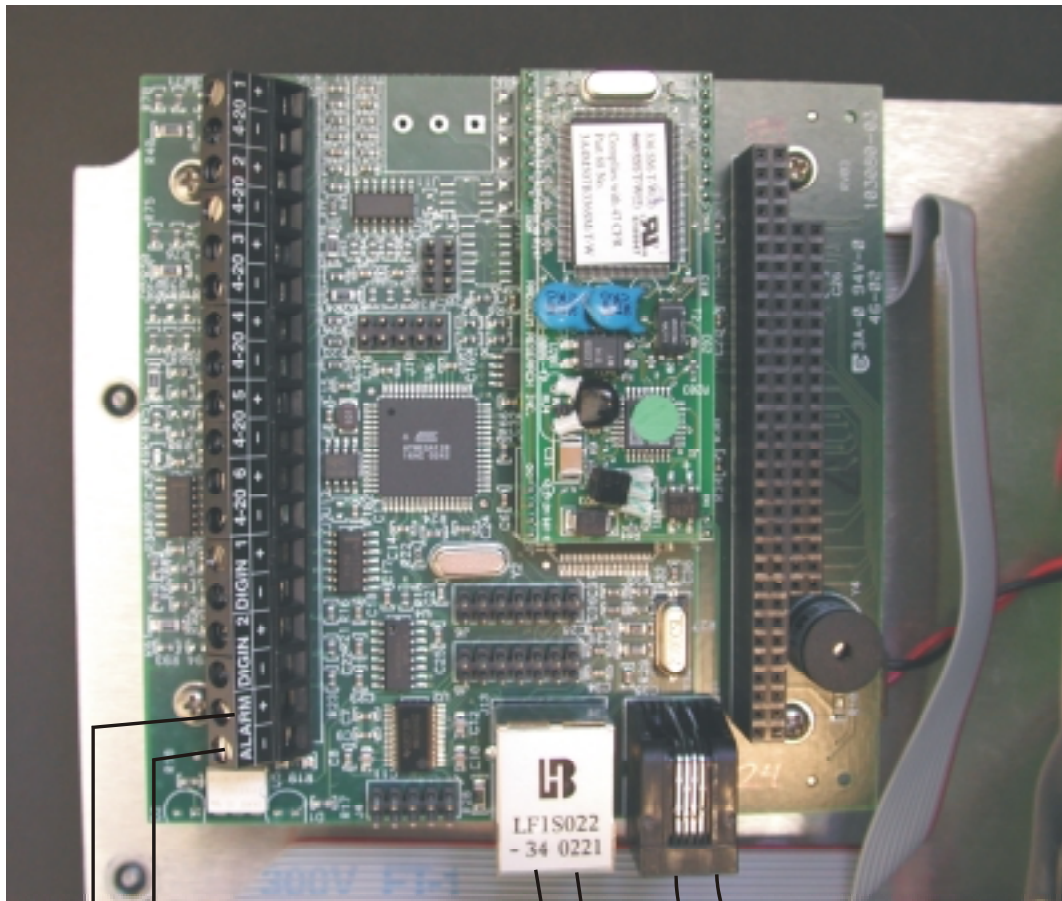

Figure 3 - Wiring Diagram for Inputs, Externally Powered



NO AC VOLTAGE !!

Figure 5 – Wiring Diagram for Digital Output and Communications

4.0 FUNCTION OVERVIEW

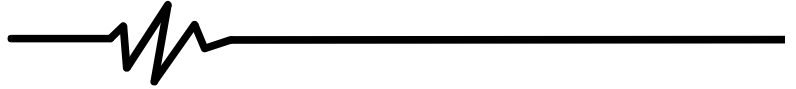

4.1 Front Panel

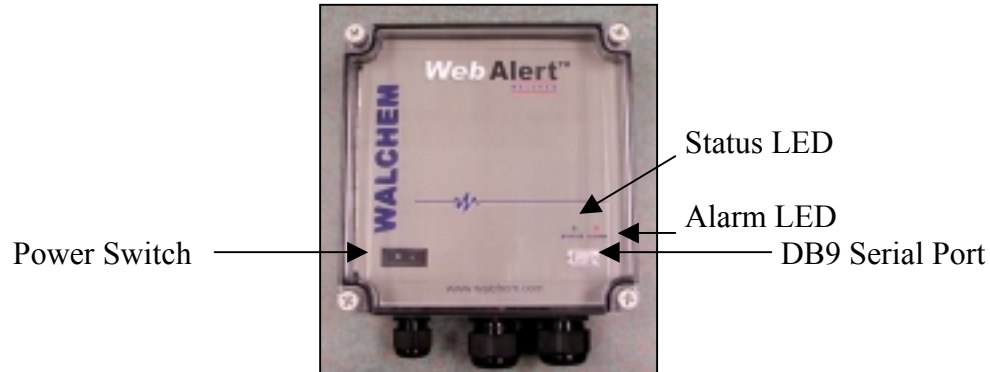

4.2 Initial Startup

Turn the power switch on. Be patient, the start up sequence will take about the same time as it takes a computer to boot up, approximately 2 minutes.

The WebAlert Series process monitors have a wide range of capabilities, so the steps required preparing the site for installation would be different depending upon the capability you will be using.

If you want to program the WebAlert using a laptop computer to connect to the serial port on the front panel of the unit, go to the section below called “Direct Serial Connection to the RS232 Port”.

If you have a unit that is equipped with a modem, then you can take full advantage of the WebAlert. The unit is like a web server. Once you set up an Internet Service Provider (ISP) account for the unit, you can “surf” to it from any web connected computer to access data or reconfigure the settings. The unit can also contact you, by email or pager, in case of trouble. In this case, a dedicated analog phone line that does not go through a company switchboard for the controller must be provided. For details, go to the section below called “Remote Modem Access: Shoulder Tap.” The ISP information must be entered into the WebAlert via direct serial connection to the RS232 port or via the Direct Modem method before attempting a Shoulder Tap connection.

If you have not yet set up an ISP account and wish to program the WebAlert from a remote location, or if you just prefer the “old fashioned method” of direct modem-to-modem communication, go to the section below called “Direct Modem Access: Direct Tap.”

If you can use the Ethernet connection installed, then the WebAlert becomes another PC on a network. You can use your web browser software, enter the unit’s address (assigned by your network administrator) and access data or reconfigure the unit. You will need to have a network node nearby (within 100 meters/330 feet) to connect your WebAlert process monitor. See the section below called “Ethernet Connection to LAN”.

You may also use the Ethernet card in your laptop to communicate with the Ethernet connection in the WebAlert. This requires a special null cable and the Ethernet parameters must be programmed into the WebAlert using either direct serial to the RS232 port, or the optional Direct Modem connection. Refer to the section below called “Direct Ethernet (for a WebAlert not connected to the LAN).”

Uploading Configuration Files

You can save all of the set points from a previously programmed unit, and then upload the same set points into another unit. If you have already downloaded a configuration file from a previously programmed unit, you can upload that file to this unit in order to make all the set points the same. If you want to save the set points of this unit for use in future units, or want to program this unit using a stored configuration file, refer to section 5.12 for specific instructions.

See the appropriate section above, depending upon how you plan on uploading the configuration file; via a laptop connected to the front panel, via modem, via Ethernet connection, or via local PC connected to the RS232 port.

4.3 Communicating with the WebAlert

4.3.1 Direct Serial Connection to the RS232 Port

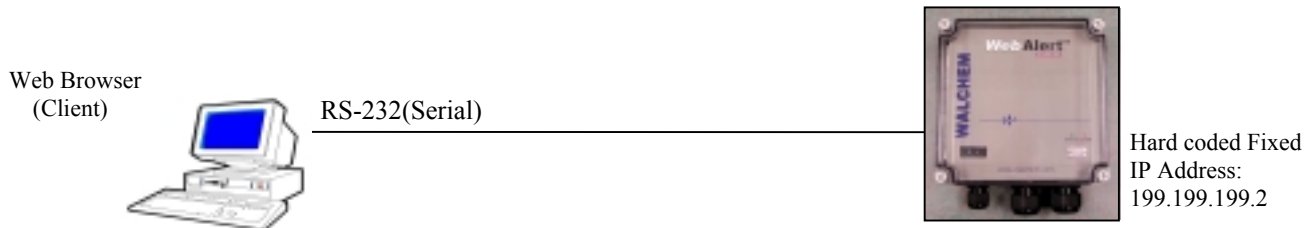

A temporary connection can be made between a laptop and the front panel of the unit.

Equipment Required

- A serial null modem cable (PC-AT) with the appropriate connectors to connect your computer to the WebAlert. If connecting temporarily to the front panel of the controller, this will be a DB9F connector. This cable is supplied with your WebAlert.
- An Internet-ready computer with the following capabilities: 100 MHz minimum processor speed, 40 MB minimum RAM, Windows operating system, and Windows Internet Explorer version 5.0 or higher web browser software.

Features Required in the WebAlert

- Any WebAlert process monitor is capable of a direct serial connection.

Utilities you need to set up on your computer

- A null modem driver, that is included with the controller, must be installed on your computer. Refer to the separate detailed instructions for this procedure.
- A Windows Dialup Networking Adapter must be created in order to establish a communication between the controller and your PC. Refer to the separate detailed instructions for this procedure.

Parameters that need to programmed into the WebAlert

- The WebAlert is capable of this type of communication without any programming by the user prior to attempting the communication.

Steps Required to Establish a Connection

- Install the null modem driver on your PC. This needs to done only once for each PC that will be used to communicate with a WebAlert controller.
- Create the dialup networking adapter on your PC. This needs to done only once for each PC that will be used to communicate with a WebAlert controller.
- Connect the null modem cable between the PC and the WebAlert.
- Use the dialup networking adapter to connect the PC to the WebAlert.
- Open Internet Explorer and type in the address 199.199.199.2. The sign-on screen for the WebAlert will come up.
- The sign-on screen of the WebAlert will come up. Type the User Name and Password (Access Code) in the text boxes and click the Submit button. The default user name is "webalert" and the default passwords are "2001" for full access, "2002" for calibration only, and "2003" for read only. These defaults can and should be changed in the Access Code page.

4.3.2 Remote Modem Access: Shoulder Tap

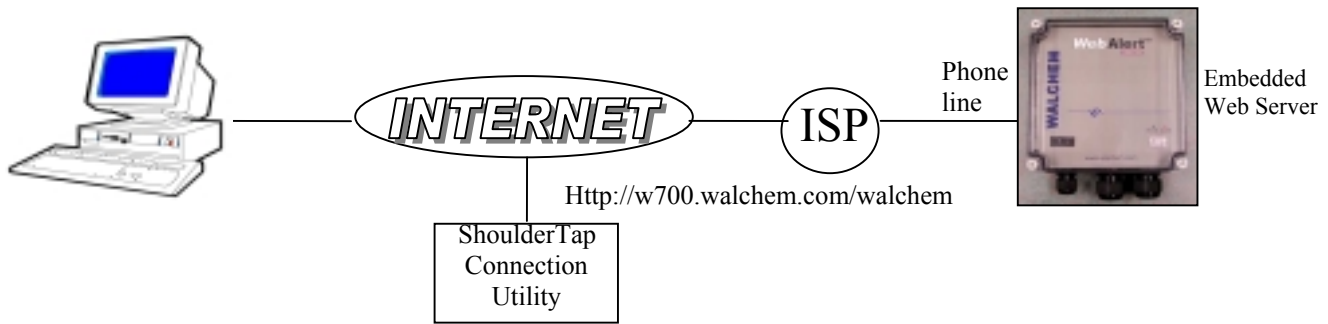

Equipment Required

- An Internet-ready computer with the following capabilities: 100 MHz minimum processor speed, 40 MB minimum RAM, Windows operating system, and Windows Internet Explorer version 5.0 or higher web browser software.
- An active analog phone line, direct to the controller (without a PBX system in between) must be connected to the modem of the WebAlert.
- A dialup account must be established for the WebAlert with an Internet Service Provider (ISP). The connection will only be as reliable as the ISP. You should avoid small mom-and-pop ISPs unless you know that they can provide reliable connection to the Internet. Contact Walchem for recommendations.

Features Required in the WebAlert

- The WebAlert must have the modem option installed in order to communicate via Shoulder Tap.

Utilities you need to set up on your computer

- There are no special drivers, adapters or other software components required on the PC.

Parameters that need to be programmed into the WebAlert

- Prior to attempting a Shoulder Tap connection, the following information needs to be entered into the Communications page of the WebAlert, either via a direct serial connection or direct modem connection (Direct Tap). Some of this information needs to be provided to you by the Internet Service Provider (ISP) that the WebAlert will use to access the Internet.
- The unit's phone number.
- The local access phone number for the ISP. More than one access number may be entered.
- The ISP Username that the unit will use to connect to the ISP.
- The ISP Password that the unit will use to connect to the ISP.

Steps Required to Establish a Connection

- Connect your PC to the Internet.
- Enter the address <http://w700.walchem.com/walchem/frontdoor.asp>.
- Enter the Connection Utility Username and Password and click the Submit button.
- Enter the phone number of the unit and click the Connect button. After a few minutes, the sign-on screen for the WebAlert will come up.
- The sign-on screen of the WebAlert will come up. Type the User Name and Password (Access Code) in the text boxes and click the Submit button. The default user name is "webalert" and the default passwords are "2001" for full access, "2002" for calibration only, and "2003" for read only. These defaults can and should be changed in the Access Code page.

4.3.3 Ethernet Connection to LAN

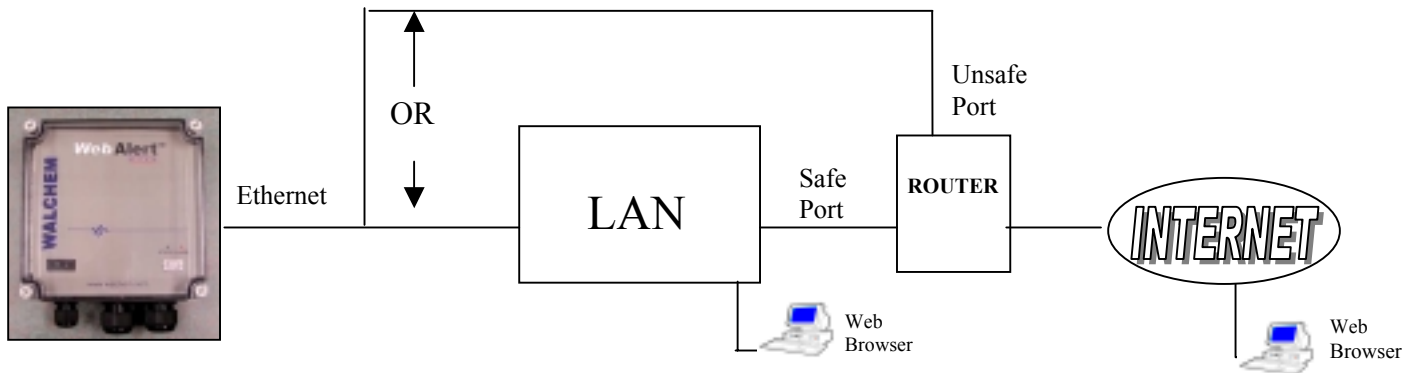

Equipment Required

- An Internet-ready computer with the following capabilities: 100 MHz minimum processor speed, 40 MB minimum RAM, Windows operating system, and Windows Internet Explorer version 5.0 or higher web browser software.
- A connection between the PC and the local area network (LAN).
- An Ethernet connection between the WebAlert and the LAN.

Features Required in the WebAlert

- All WebAlert process monitors are capable of Ethernet communications.

Utilities you need to set up on your computer

- There are no special drivers, adapters or other software components required on the PC.

Parameters that need to be programmed into the WebAlert

- Prior to attempting an Ethernet connection, the following information needs to be entered into the Communication page of the WebAlert, either via a direct serial connection or via the Direct Modem option. This information must be provided by the IT Administrator of the LAN.
- The Ethernet IP address of the WebAlert. If the unit will only be accessed by computers on the LAN then this may be a fake IP address. If the unit needs to be accessible by computers not on the LAN then this must be a real IP address.
- The Subnet Mask.
- The Gateway IP address.

Steps Required to Establish a Connection

- Open Internet Explorer.
- Type in the Ethernet IP address that has been assigned by the IT Administrator.
- The sign-on screen of the WebAlert will come up. Type the User Name and Password (Access Code) in the text boxes and click the Submit button. The default user name is "webalert" and the default passwords are "2001" for full access, "2002" for calibration only, and "2003" for read only. These defaults can and should be changed in the Access Code page.

4.3.4 Direct Modem Access: Direct Tap

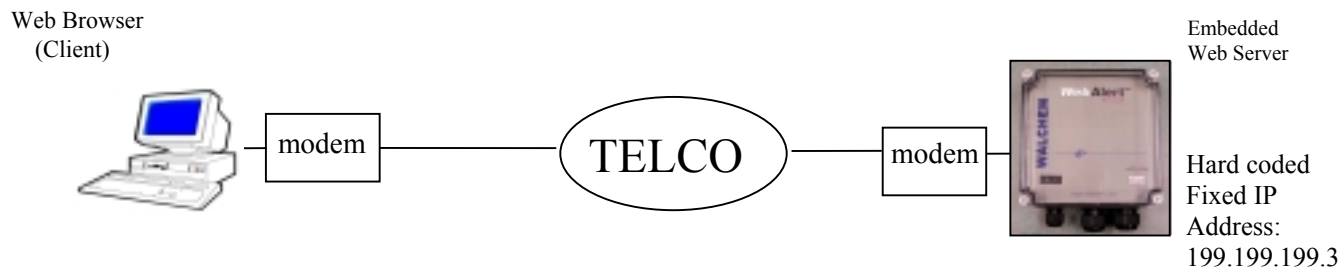

Equipment Required

- An Internet-ready computer with the following capabilities: 100 MHz minimum processor speed, 40 MB minimum RAM, Windows operating system, modem and Windows Internet Explorer version 5.0 or higher web browser software.
- An active analog phone line, direct to the controller (without a PBX system in between) must be connected to the modem of the WebAlert.

Features Required in the WebAlert

- The WebAlert must have the modem option installed in order to communicate via Direct Tap.

Utilities you need to set up on your computer

- A Windows dialup networking adapter must be created. This dialup networking adapter is similar to but not identical to the one used in a direct serial connection. Refer to the separate detailed instructions for this procedure.

Parameters that need to be programmed into the WebAlert

- The WebAlert is capable of this type of communication without any programming by the user prior to attempting the communication.

Steps Required to Establish a Connection

- Create the dialup networking adapter on your PC. This needs to be done only once for each PC that will be used to communicate with a WebAlert controller.
- Use the dialup networking adapter to connect the PC to the WebAlert.
- Open Internet Explorer.
- Type in the address 199.199.199.3. The sign-on screen for the WebAlert will come up.
- The sign-on screen of the WebAlert will come up. Type the User Name and Password (Access Code) in the text boxes and click the Submit button. The default user name is "webalert" and the default passwords are "2001" for full access, "2002" for calibration only, and "2003" for read only. These defaults can and should be changed in the Access Code page.

4.3.5 Direct Ethernet (for a WebAlert not connected to a LAN)

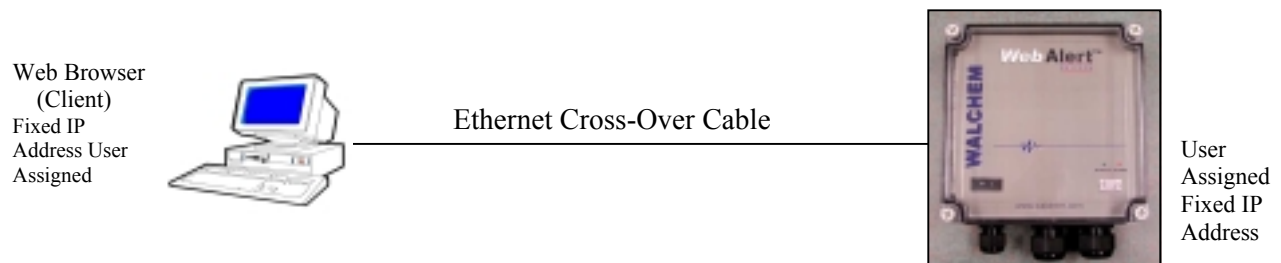

Equipment Required

- An Internet-ready computer with the following capabilities: 100 MHz minimum processor speed, 40 MB minimum RAM, Ethernet card, Windows operating system, and Windows Internet Explorer version 5.0 or higher web browser software.
- A null Ethernet cable connection between the PC and WebAlert.

Features Required in the WebAlert

- All WebAlert process monitors are capable of Ethernet communications.

Utilities you need to set up on your computer

- There are no special drivers, adapters or other software components required on the PC. However if your laptop is used on a LAN it is likely that you will have to change your network TCP/IP properties to use a specific IP address for your PC instead of obtain an IP address automatically. You will have to specify the IP address, as well as the Subnet Mask and Gateway IP address. Refer to the separate detailed instructions for this procedure.

Parameters that need to be programmed into the WebAlert

- Prior to attempting an Ethernet connection, the following information needs to be entered into the Communication page of the WebAlert, either via a direct serial connection or via the Direct Modem option.
- The Ethernet IP address of the WebAlert.
- The Subnet Mask.
- The Gateway IP address.

Steps Required to Establish a Connection

- Open Internet Explorer.
- Type in the Ethernet IP address that has been assigned to the WebAlert.
- The sign-on screen of the WebAlert will come up. Type the User Name and Password (Access Code) in the text boxes and click the Submit button. The default user name is "webalert" and the default passwords are "2001" for full access, "2002" for calibration only, and "2003" for read only. These defaults can and should be changed in the Access Code page.

4.3.6 Networking WebAlert Controllers via Ethernet

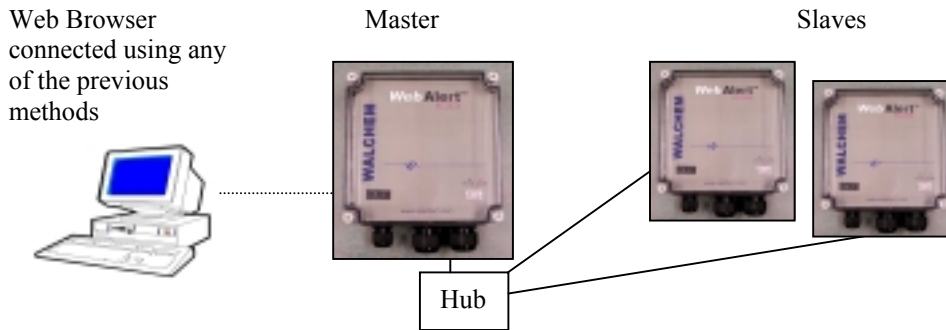

Equipment Required

- An Internet-ready computer with the following capabilities: 100 MHz minimum processor speed, 40 MB minimum RAM, Ethernet card, Windows operating system, and Windows Internet Explorer version 5.0 or higher web browser software.
- An Ethernet cable connection between each WebAlert using a hub or connection to LAN.

Features Required in the WebAlert

- All WebAlert process monitors are capable of Ethernet communications.
- The software ID must be s250v002 or higher to support networking.
- The Master must be purchased with the Master networking capability activated.

Utilities you need to set up on your computer

- There are no special drivers, adapters or other software components required on the PC to support networking. Refer to the previous sections for connecting to the master controller via RS232, Ethernet, or modem.

Parameters that need to be programmed into the WebAlert

- Prior to attempting an Ethernet connection, the following information needs to be entered into the Communication page of each WebAlert on the network, either via a direct serial connection or via the local keypad.
- The Ethernet IP address of the WebAlert.
- The Subnet Mask.
- The Gateway IP address.
- The master must be selected as the master, and the slaves selected as slaves.
- Power must be cycled off and back on in order for the Ethernet changes to take affect, and for the master to detect the slaves.

Steps Required to Establish a Connection

- Connect to the master controller using one of the methods described in sections 4.3.1 through 4.3.5.
- The sign-on screen of the WebAlert will come up. Type the User Name and Password (Access Code) in the text boxes and click the Submit button. The default user name is "webalert" and the default passwords are "2001" for full access, "2002" for calibration only, and "2003" for read only. These defaults can and should be changed in the Access Code page.
- Once connected to the master, you may connect to the slaves by clicking on the link under the heading of "Sub-Network".
- You must log onto each slave using its user name and password.

4.4 Startup

Once the WebAlert has been set up for your application, start up is a simple process. Simply turn on the power, and it will begin monitoring the process.

4.5 Shut Down

To shut down the controller, simply turn off the power. All set points will be retained in memory.

5.0 OPERATION



When you first access the process monitor, the System Summary page will be displayed in the main frame of the browser, and the Name of the unit and Alarm Status will be displayed in the top frame. Links to each main menu page are located along the left side of the screen.

The menu pages are grouped by inputs, outputs, and utilities. Each input has fields for defining the type of input, selecting units of measure, etc. as required. The alarm output has menus for selecting the types of errors that will trigger the relay, page or email notification. The utilities allow you to set up the data logging, auto-reporting, access codes, communications, etc.

5.1 Menu Selection Links

Along the left side of your PC monitor will be links to the various menu pages. Below is a list of all possible Menu selections.

- Startup
- System Summary
- 4-20 mA Inputs
- 4-20 mA Calibration
- Digital Inputs
- Alarm
- Data Logging
- Auto Reporting
- Communications
- Software Upgrade (only appears if the WebAlert has an Internet connection and there is a more recent version of software available for download)
- Configuration File
- Notepad
- Access Codes
- WebAlert Help
- Walchem Home Page
- Graphing/Trending
- Advanced Comms

5.2 Startup

Select the option that you want for each of the sections on the page. When you click on the “Submit” button at the bottom of the page, your changes will take effect. If you move to another page without clicking “Submit” first, your changes will be lost!

WebAlert Name

Type the name that you want to use to identify the unit, up to 32 characters, in the text box. For example, “XYZ Corp, North Tower”.

Time and Date

Update the date and time by clicking the arrow on the pull-down list and selecting the correct values.

WebAlert Location

Type the location of the process monitor in the text box.

Date Format

Click on the radio button that corresponds to the desired date format. The choices are Month/Day/Year, Day/Month/Year or Year/Month/Day.

Units of Measure

Click on the radio button to select the preferred units of measure for volume. This will be used if an input is used for a flow meter or a level transmitter.

4-20 mA Input Assignment

Click on the radio button which best describes the devices you have attached to the 4-20 mA inputs, for each input labeled 1 through 6. Make sure that you select the type of device that is actually wired to that terminal of the card!

Not Used should be selected if nothing is connected to that input.

Level should be selected if a *continuous* level transmitter is attached to that output. For *point* level switch devices, which do not use a 4-20 mA signal, wire into and program with the Digital Inputs section.

Flow Meter should be selected if flow transmitter is connected to that input.

Generic should be selected if the 4-20 mA transmitter connected to that input is anything other than the previously mentioned ones. Later when you get to the 4-20 mA Input Page, you will be able to name the input (for example, Phosphate or System Pressure) and also define the Units of Measure (like mg/l or psi).

Digital Input Assignment

Click on the radio button that best describes the devices that you have connected to the digital inputs for each input labeled 1 through 2. Make sure that you select the type of device that is actually wired to that terminal of the card!

Not Used should be selected if nothing is attached to that input.

Paddlewheel Flow meter should be selected if a high frequency (greater than 10 Hz) Hall Effect paddlewheel flow meter is connected to that input. This option will give you the ability to specify a K Factor to convert contact closures into a flow rate.

Contact Flow meter should be selected if a low frequency (less than 10 Hz) Hall Effect or reed switch style water meter contactor is connected to that input. This option will give you the ability to specify the volume of water that will give a contact (generally in multiple gallons or liters per contact).

Level Switch should be selected if a level switch is connected to that input.

Generic Input should be selected if the digital input state (open or closed) will indicate an alarm condition or if the input state needs to be logged. The WebAlert allows you to specify a custom message to be delivered if the contact is open or closed.

Counter should be selected if you need to keep track of the rate of contact closures, or the total number of contact closures.

5.3 System Summary Menu

There are no programmable parameters in the System Summary Menu page. Several tables will be displayed, with information on 4-20 mA inputs values, alarm relay state, digital input state, active alarm messages, etc.

5.4 4-20 mA Inputs

This page is used to configure the 4-20 mA inputs. If you have set the type of input in the Startup page, this page will already be showing the correct fields to set up each input type. If you have not already set the input types, you can do that here, then click the Submit button. When the page refreshes the correct fields will appear.

Select the options that you want for each of the sections on the page. When you click on the “Submit” button at the bottom of the page, your changes will take effect. If you move to another page without clicking “Submit” first, your changes will be lost!

4-20 mA Input Assignment

Click on the radio button which best describes the devices you have attached to the 4-20 mA inputs, for each input labeled 1 through 6. Make sure that you select the type of device that is actually wired to that terminal of the card!

Not Used should be selected if nothing is connected to that input.

Level should be selected if a *continuous* level transmitter is attached to that output. For *point* level switch devices, which do not use a 4-20 mA signal, wire into and program with the Digital Inputs section.

Generic should be selected if the 4-20 mA transmitter connected to that input is anything other than the previously mentioned ones. Below you will see how to name the input (for example, Phosphate or System Pressure), scale it and define the Units of Measure (like mg/l or psi).

Flow Meter should be selected if flow transmitter is connected to that input.

Level (4-20 mA) Input Menu

(only appears if a 4-20 mA input is assigned to be a Level type)

Input

Displays which 4-20 mA inputs are defined as level inputs.

Drum

You may give the level input a custom name by typing it in the text box.

Volume

This displays the current volume of chemical remaining in that drum.

Present mA

This displays the mA output of the level transmitter, before it is converted into a volume. This is helpful for troubleshooting.

Status

This displays whether the current drum level is “Normal” or in “Low Alarm”. Possible status messages for level transmitters are; Normal (everything is OK), Sensor Error (the sensor signal is not valid), Over Range (between 20 and 21 mA), Under Range (between 3.9 and 4.0 mA), or Low Alarm.

Full Tank Volume

Type into the text box the volume contained by a full drum

mA when tank “empty”

Type into the text box the mA output that the level transmitter will send when the drum is empty.

mA when tank “full”

Type into the text box the mA output that the level transmitter will send when the drum is full.

Low Alarm Limit

Type into the text box the volume of chemical remaining in the container at which you want a low alarm to occur. You must go to the Alarm page to specify that this alarm condition is a critical alarm in order to close the alarm relay or send an email or call a pager.

Generic 4-20 mA Input

Input

Displays which 4-20 mA inputs have been selected as “Generic” type.

Custom Name

You may give the generic input a custom name by typing it into the text box. For example, a pressure transmitter can be called “Pressure”.

Present Value

This displays the current reading of the device, using the mA signal from the device, the span of the 4-20 mA signal defined in “4 mA =” and “20 mA =” below, and the units of measure defined below.

Present mA

This displays the present raw mA signal from the device. This is helpful in troubleshooting.

Status

This displays whether the present value is “Normal”, or in a “Low Alarm” or “High Alarm” condition. Possible status messages are; Normal (everything is OK), Sensor Error (the sensor signal is not valid), Over Range (between 20 and 21 mA), Under Range (between 3.9 and 4.0 mA), High Alarm, or Low Alarm.

4 mA =

Type into the text box the value that corresponds to a 4 mA output signal from the device. For example, if the pressure transmitter sends out 4 mA at 0.00 psi, type in 0.00. Any value between –100,000 and 100,000 is acceptable.

20 mA =

Type into the text box the value that corresponds to a 20 mA output signal from the device. For example, if the pressure transmitter sends out 20 mA at 100 psi, type in 100. Any value between –100,000 and 100,000 is acceptable.

Units

Type into the text box the units of measure that you want to use for the device connected to that input. For example, you could use “psi”, “mg/l chlorine”, etc.

Low Alarm Limit

Type into the text box the value for that input below which you want a low alarm to occur. Any value between –100,000 and 100,000 is acceptable. You must go to the Alarm page to specify that this alarm condition is a critical alarm in order to close the alarm relay or send an email or call a pager.

High Alarm Limit

Type into the text box the value for that input above which you want a high alarm to occur. Any value between –100,000 and 100,000 is acceptable. You must go to the Alarm page to specify that this alarm condition is a critical alarm in order to close the alarm relay or send an email or call a pager.

Flow meter 4-20 mA Input**Input**

Displays which 4-20 mA inputs have been selected as “Flow meter” type.

Custom Name

You may give the input a custom name by typing it into the text box.

Rate

This displays the current reading of the flow meter, using the mA signal from the device, the span of the 4-20 mA signal defined in “4 mA =” and “20 mA =” below, and the units of measure defined below.

Present mA

This displays the present raw mA signal from the flow meter. This is helpful in troubleshooting.

Status

This displays whether the present value is “Normal”, or in a “Low Alarm” or “High Alarm” condition. Possible status messages are; Normal (everything is OK), Sensor Error (the sensor signal is not valid), Over Range (between 20 and 21 mA), Under Range (between 3.9 and 4.0 mA), High Alarm, Low Alarm or Total Limit.

4 mA =

Type into the text box the value that corresponds to a 4 mA output signal from the device. For example, if the flow transmitter sends out 4 mA at 0.00 gpm, type in 0.00. Any value between -100,000 and 100,000 is acceptable.

20 mA =

Type into the text box the value that corresponds to a 20 mA output signal from the device. For example, if the flow transmitter sends out 20 mA at 100 gpm, type in 100. Any value between -100,000 and 100,000 is acceptable.

Units

Type into the text box the units of measure that you want to use for the device connected to that input. For example, you could use “gal”, etc.

Low Alarm Limit

Type into the text box the value for that input below which you want a low alarm to occur. Any value between -100,000 and 100,000 is acceptable. You must go to the Alarm page to specify that this alarm condition is a critical alarm in order to close the alarm relay or send an email or call a pager.

High Alarm Limit

Type into the text box the value for that input above which you want a high alarm to occur. Any value between -100,000 and 100,000 is acceptable. You must go to the Alarm page to specify that this alarm condition is a critical alarm in order to close the alarm relay or send an email or call a pager.

5.5 4-20 mA Calibration

This page is used to calibrate the 4-20 mA inputs of the WebAlert.

Following the instructions of your 4-20 mA transmitter, supply the WebAlert with a 4 mA signal for each input. Verify that the transmitter is accurate by measuring it with an ammeter. The column in the WebAlert table will show the **Present mA Reading**. If this does not read exactly 4.00 mA, then click the button labeled **Set 4 mA** and you will be prompted to perform the calibration. If you click Yes, the WebAlert will adjust the Present mA Reading to 4.00 mA. If the value is more than 2 mA from 4 mA, then a Range Error message will appear and the calibration will not be changed.

Repeat this process for each transmitter, except provide a 20 mA signal to the WebAlert. If the Present mA Reading does not read exactly 20 mA, click the button labeled **Set 20 mA** and you will be prompted to perform the calibration. If you click Yes, the WebAlert will adjust the Present mA Reading to 20.00 mA. If the value is more than 2 mA from 20 mA, then a Range Error message will appear and the calibration will not be changed.

5.6 Digital Inputs

This page is used to configure the digital inputs. If you have set the type of input in the Startup page, this page will already be showing the correct fields to set up each input type. If you have not already set the input types, you can do that here, then click the Submit button. When the page refreshes the correct fields will appear.

Select the options that you want for each of the sections on the page. When you click on the “Submit” button at the bottom of the page, your changes will take effect. If you move to another page without clicking “Submit” first, your changes will be lost!

Digital Input Assignment

Click on the radio button that best describes the devices that you have connected to the digital inputs for each input labeled 1 and 2. Make sure that you select the type of device that is actually wired to that terminal of the card!

Not Used should be selected if nothing is attached to that input.

Paddlewheel Flow meter should be selected if a high frequency (greater than 10 Hz) Hall Effect paddlewheel flow meter is connected to that input. This option will give you the ability to specify a K Factor to convert contact closures into a flow rate.

Contact Flow meter should be selected if a low frequency (less than 10 Hz) Hall Effect or reed switch style water meter contactor is connected to that input. This option will give you the ability to specify the volume of water that will give a contact (generally in multiple gallons or liters per contact).

Level Switch should be selected if a level switch is connected to that input.

Generic Input should be selected if the digital input state (open or closed) will indicate an alarm condition or if the input state needs to be logged. The WebAlert allows you to specify a custom message to be delivered if the contact is open or closed.

Counter should be selected if you need to keep track of the rate of contact closures, or the total number of contact closures.

Paddlewheel Flow meter

Custom Name

You may give the input a custom name by typing it in the text box.

Total

The total water flow since the last time the total was reset will be displayed here. The Reset Total button allows you to set the total back to 0.

Rate

The current flow rate will be displayed here. The units of measure used is defined below.

Last Total Reset

The date and time of the last time the total was reset will be displayed here.

Status

This menu reports the status of the input. Possible messages are Normal, High Alarm, Low Alarm, or Total Limit.

Units

Select the units of flow that you want to use. The choices are Gallons, Liters or Cubic Meters per minute.

K Factor

The instructions for the flow meter, or the flow meter itself should have the K Factor (pulses per unit volume) that is necessary to calculate the flow rate. Type this into the text box.

Total Alarm Limit

You may specify a total amount of volume accumulated above which an alarm message will occur. Type this in the text box. You must go to the Alarm page to specify that this alarm condition is a critical alarm in order to close the alarm relay or send an email or call a pager.

Rate High Alarm

You may specify a flow rate above which an alarm message will occur. Type this in the text box. You must go to the Alarm page to specify that this alarm condition is a critical alarm in order to close the alarm relay or send an email or call a pager.

Rate Low Alarm

You may specify a flow rate below which an alarm message will occur. Type this in the text box. You must go to the Alarm page to specify that this alarm condition is a critical alarm in order to close the alarm relay or send an email or call a pager.

Contact Flow meter**Custom Name**

You may give the input a custom name by typing it in the text box.

Total

The total water flow since the last time the total was reset will be displayed here. The Reset Total button allows you to set the total back to 0.

Last Total Reset

The date and time of the last time the total was reset will be displayed here.

Status

This menu reports the status of the input. Possible messages are Normal or Total Limit.

Units

Select the units of flow that you want to use. The choices are Gallons, Liters or Cubic Meters per minute.

Volume per Contact

The instructions for the flow meter, or the flow meter itself should have the volume per contact that is necessary to calculate the total flow. Type this into the text box.

Total Alarm Limit

You may specify a total amount of volume accumulated above which an alarm message will occur. Type this in the text box. You must go to the Alarm page to specify that this alarm condition is a critical alarm in order to close the alarm relay or send an email or call a pager.

Level Switch**Custom Name**

You may give the input a custom name by typing it in the text box.

Status

This menu reports the status of the input. Possible messages are Normal or Low.

Drum Low when Contact is

Select the state of the level switch that indicates that the level is low: either open or closed.

Generic Input

Custom Name

You may give the input a custom name by typing it in the text box.

Custom Message for Open Contact

You may specify a custom message to be displayed in the System Summary when the digital input contact is open. Type it in the text box.

Custom Message for Closed Contact

You may specify a custom message to be displayed in the System Summary when the digital input contact is closed. Type it in the text box.

Alarm Active when Contact is

Select the state of the digital input that corresponds to an alarm condition. If Open or Closed is selected, then when the switch is in that state the critical alarm action specified in the Alarm page will occur. If Neither is selected, then neither contact state will initiate the critical alarm action.

Counter

Custom Name

You may give the input a custom name by typing it in the text box.

Total

The total number of counts since the last time the total was reset will be displayed here. The Reset Total button allows you to set the total back to 0.

Last Total Reset

The date and time of the last time the total was reset will be displayed here.

Rate

The current rate of contact closures will be displayed here. The unit of measure used is defined below.

Status

This menu reports the status of the input. Possible messages are Normal, High Alarm, Low Alarm, or Total Limit.

Custom Units

Select the units of measure that you want to use. Type the name in the text box.

One Count =

This menu allows you to specify that each count (contact closure) signifies a certain number of the custom units of measure. For example, one count could equal 100 liters of fluid.

Total Alarm Limit

You may specify a total number of counts accumulated above which an alarm message will occur. Type this in the text box. You must go to the Alarm page to specify that this alarm condition is a critical alarm in order to close the alarm relay or send an email or call a pager.

Rate High Alarm

You may specify a contact rate above which an alarm message will occur. Type this in the text box. You must go to the Alarm page to specify that this alarm condition is a critical alarm in order to close the alarm relay or send an email or call a pager.

Rate Low Alarm

You may specify a contact rate below which an alarm message will occur. Type this in the text box. You must go to the Alarm page to specify that this alarm condition is a critical alarm in order to close the alarm relay or send an email or call a pager.

Rate Units

Use the pull-down to specify the units of measure for the rate. The choices are pulses per second, minute, hour, day, week, month, or year.

5.7 Alarm

This page is used to configure the Alarm Output. Select the options that you want for each of the sections on the page. When you click on the “Submit” button at the bottom of the page, your changes will take effect. If you move to another page without clicking “Submit” first, your changes will be lost!

Alarm Condition

In the left hand column, a list of all possible alarm conditions will be displayed. Only the alarm conditions that are possible given how your controller is configured will appear. To the right of each type of alarm condition there will be a column labeled Critical Alarm with a choice of “Yes” or “No”. Click on the “No” radio button if you do not want that type of alarm to be considered critical.

If an alarm condition is selected as a critical alarm, then you have the option of being notified that the alarm condition exists, by triggering the alarm relay, sending an email, or calling a pager.

The WebAlert will attempt to send the alarm message email five times at 5 minute intervals and will then stop trying, even if unsuccessful.

Alarm Status

This menu is for information only, and tells you if the alarm relay is currently on or off, and if it is on, for how much time. Possible status messages are Off, Off | Manual, On - Time counting up (indicating how long the alarm relay has been active) and On - Time counting down | Hand (for manual output activation).

Critical Alarm Action

Click on the check box to the left of the action or actions that you want to occur if a critical alarm condition exists. The controller can close or open the alarm relay, send an email or dial a pager, or any combination of the above.

Auto Dial Delay Time

In order to avoid being notified of an alarm condition that quickly corrects itself, you may set a delay time for the alarm action. If the alarm condition still exists at the end of the delay time, then the alarm action will occur. If the alarm condition no longer exists at the end of the delay time, no notification will occur. Any value between 0 and 1440 minutes is acceptable.

Active When Relay Is

Click on the radio button that describes how you want the alarm relay to act. The normal method is to close the relay when an alarm condition exists, but you can also open the relay.

Output Mode

Click on the radio buttons to manually control the alarm relay. The normal selection will be *Auto*, where the WebAlert uses the various set points to open and close the relay. You can force the relay open regardless of the presence of an alarm condition by selecting *Off*, or force the relay closed regardless of the presence of an alarm condition by selecting *Hand*.

If you select *Off*, the alarm relay will not be triggered again until either *Hand* or *Auto* is selected, or unless power to the unit is cycled off and on! If you select *Hand*, the relay will be closed until either *Auto* or *Off* is selected, or until the Hand Time Limit (programmed in the next menu) expires.

The *Off* mode is handy to use as an alarm silence. The *Hand* mode is handy to be able to test the relay, wiring, etc without needing to force an alarm condition.

Hand Time Limit

Type in the text box the maximum number of minutes that the alarm output can be activated in the *Hand* mode. Any value between 0 and 1440 is acceptable. A value of 0 means the output can be left on indefinitely.

Log File

Click the link to View Log File. The Alarm Log will tell you the status of any alarm emails that may have been sent. It will show you the date and time of the alarm, the method of alarm notification, whether it was successful at sending the message or not, and the type of alarm.

A window will open to ask if you would like to open the file or save it to disc. Select the method you would like to use. The file is a basic text file with a .log extension that may be opened in any word processing program (Word, Notepad, etc.).

5.8 Data Logging

This page is used to configure the data log. Select the options that you want for each of the sections on the page. When you click on the “Submit” button at the bottom of the page, your changes will take effect. If you move to another page without clicking “Submit” first, your changes will be lost!

Manual Data logging

You may either download data files automatically, or manually. To download automatically, click the *Disable* radio button, and set up the schedule in the Auto Reporting page (See Section 5.9). To download manually, click the *Enable* radio button, then go to the bottom of the page and click the Submit Datalog Details button.

Note that if you have an automatic data log building, and you click the *Enable* radio button to download data manually, the filtered set of data previously gathered will be lost!

You will now see additional menus, which allow you to set the start date and end date of the manual log, as well as the frequency of logging data points. Type the desired values in the text boxes.

You will also get a link on the bottom of the page, Manual Download, which will initiate the downloading process of this file. You will be presented with the standard Windows dialog box, asking you what the file should be named and where you want the file to be saved.

Select the Measurements to Include in the Data Log File

You will be presented with a list of all of the parameters that can be logged, including 4-20 mA input values, flow meter or counter totals and rates, drum levels, and digital input or output state. The contents of the list will vary depending on what options you have installed or programmed. Click the “Yes” radio buttons of the parameters that you want to log, and the “No” radio buttons of the parameters that you do not want to log.

To download the active data log, click the “Active Log Download” link and another window will open. The WebAlert stores all parameters (used or not) every 20 minutes for 32 days, and this log contains everything. You will be presented with the standard Windows dialog box, asking you what the file should be named and where you want the file to go.

5.9 Auto Reporting

This page is used to configure the automatic reports. Select the options that you want for each of the sections on the page. When you click on the “Submit” button at the bottom of the page, your changes will take effect. If you move to another page without clicking “Submit” first, your changes will be lost!

There are two types of reports that may be sent to you automatically. One is a system summary report, which will contain all of the information that is found on the System Summary page. This includes 4-20 mA inputs with a 24 hour minimum, maximum and average calculated, alarm relay status, level switch status, digital input state, water meter totals and rates, and any active alarms. This report will be sent by email.

The other type of automatic report is a data log report. This report will email a data log file of any parameters that you selected in the Data Logging page. This file may be opened in a spreadsheet for graphing or other data manipulation. This report may be sent on a cyclical schedule or over a specific date range.

System Status Reporting

Click the appropriate radio button to enable or disable the system status report feature.

Data Log Reporting

Click the appropriate radio button to enable or disable the data log report feature.

Log File

Click on the link called Log to manually download the Report log. This log details the date and time of the report, which type of report was sent, how the report was sent (email via modem, or email via Ethernet), if the report was sent successfully or not, and if not, what the problem was. You will be presented with the standard Windows dialog box asking if you want to open the file or save it. If it’s to be saved, it asks you what the file should be named and where you want the file to go.

System Status Reporting, Status

This menu is informational only, telling you when the next report is due to be sent.

System Status Reporting, Reporting Mode

Click the appropriate radio button to select an Hourly, Daily, Weekly, Biweekly, or Monthly report frequency. Type the time of day for receiving the report in the text boxes, and use the pull down menus to select the desired day, and to select AM or PM.

Important: If this unit is part of a network of controllers, you must stagger the reports from each controller in the network to occur at least an hour apart. Failure to do so could result in lost reports!

Report Testing

Click the Send a Test Report Now button to see if the report will be sent correctly. The email address entered in the Communications page will be used. If you haven't already entered this information, go the Communications page and do so before trying a test report. The unit must have an email address, an SMTP IP address, and access to the Internet before a test report may be sent successfully. See section 5.10.

Data Log Auto Reporting, Reporting Mode

Click the appropriate radio button to select either a Cyclical report schedule or a Calendar report schedule. A cyclical report is more convenient since it will automatically be sent every week, month, etc. The calendar report will be sent for a certain date range, and then once that date has gone by, the next date range needs to be specified or another report will never be sent!

Data Log Auto Reporting, Logging Frequency

Type the frequency of the data points into the text box.

Data Log Auto Reporting, Log Duration

If you have selected a cyclical schedule, select a Daily, Weekly, Biweekly, or Monthly report frequency. Type the time of day for receiving the report in the text boxes, and use the pull down menus to select the desired day, and to select AM or PM.

If you have selected a calendar report, select the start date and time, and the end date and time.

Important: If this unit is part of a network of controllers, you must stagger the reports from each controller in the network to occur at least an hour apart. Failure to do so could result in lost reports!

Opening a data log file

To open the data log file using Excel, follow these steps:

Open Excel.

Click Open.

Change the "Look In" to the location of the log file.

Change the "Files of Type" from "Microsoft Excel Files" to "All Files".

Select the log file and click "Open".

A Text Import Wizard will appear. Select the file type as "Delimited" then click "Next".

Select the delimiter as "Comma" then click "Finish".

5.10 Graphing/Trending

Recent data may be viewed in a graphic format on-line without downloading it to a computer first, and without opening it in a spreadsheet.

At the top of the page, a selection of boxes will be displayed. Check the box of the parameter that you would like to see graphed. The choices will be any direct sensor input and any 4-20mA input that is being used. Then select the Time Span of the data by selecting it from the pull-down. The choices are Last Hour, Day, 7 Days, 14 Days and 32 Days.

Click the Submit button for the changes to take effect.

The graphs selected will be presented below.

5.11 Communications

Internet Dial Up Account

Controller ISP User Name

When the controller needs to dial out and connect to the Internet Service Provider, it needs to identify itself with a user name, so that the ISP knows that it has an account. Type in the text box the user name that the controller will use.

Controller ISP Password

Similarly, the controller needs to identify itself with a password in order to connect with the ISP. Type in the text box the password that the controller will use. The password can also be changed here.

Primary ISP Phone No.

Type in the text box the first phone number for the controllers Internet Service Provider. This will be the phone number that it attempts to dial first.

Secondary ISP Phone No.

Type in the text box the second phone number for the controllers Internet Service Provider. This will be the phone number that it attempts to dial second, if the first number doesn't respond.

Controller Phone No

When you need to communicate with the controller, you go to the Walchem web site, link to the Webmaster access page, and a call is made from our server to the controller to wake it up. Type in the text box the phone number for the line to which the Webmaster is connected. Use the pull down menu to select the country where the controller is located.

Email

Email 1st Address

When the Webmaster needs to send an email for notification of an alarm condition, or to send out a scheduled report, this is the first email address that it will use. Type in the text box the address to which you want the controller to send emails.

Email 2nd Address

If the emails need to be sent to more than one address, enter the second address in this text box.

Email 3rd Address

If the emails need to be sent to more than one address, enter the third address in this text box.

Email 4th address

If the emails need to be sent to more than one address, enter the fourth address in this text box.

Cell Phone Text Message

The email message above is in html format and will not be displayed correctly on a cell phone. The cell phone text message email will be truncated. Data log and summary reports are not sent to these addresses, only alarm emails.

1st Address – 4th Address

Type in the text box the addresses for a text message to be sent. Up to four addresses are available.

SMTP IP Address

In order for the controller to send an email, the email must first be routed to the SMTP IP address that the Internet Service Provider specifies. Obtain this address from your ISP and type it into the text box.

Controller email Address

The controller needs to be given an email address, which your ISP uses to identify the controller as having an account, so that the ISP will accept the email that the controller is sending, and route it to the intended recipient. Type in the text box the controller's email address.

Send Email Via

If you have both a modem card and an Ethernet card installed, click on the radio button of which you need to use to send an email notification of an alarm condition, or an automatic report.

Pager**Primary Pager No.**

If there is a pager that you want to be called in case of an alarm condition, type the telephone number in this text box.

Primary Pager PIN

Enter the primary pager's PIN number in this text box.

Secondary Pager No.

If there is another pager that should be used in an alarm condition, type the telephone number in this text box.

Secondary Pager PIN

Enter the PIN number for the secondary pager in this text box.

PIN Delay

Some pagers make you wait for a message to finish before prompting you to dial the PIN number. If the pager requires a pause before dialing the PIN number, type the number of seconds to wait between the answering service picking up and the PIN number being dialed. Any value between 1 and 60 seconds is acceptable.

Controller ID

When the controller calls a pager, it will leave a numeric message that is its phone number. You can have the controller dial some numbers attached to the end of the phone number to let you know that this is a controller calling and not some long-lost friend. Type in some code, for example *999, that will remind you that it is a controller calling.

Ethernet (LAN)**Network Mode**

If you have purchased the software to allow networking of controllers via Ethernet, use the pull down arrow to select the role that this controller will serve on the network. If it is not part of a network of WebMaster controllers, select “Independent”. If it is the Master, select “Master”. If it is the Slave, select “Slave”. Once the network mode has been selected, the power to the controller must be cycled in order for the change to take effect.

Network Detection

Click on the Detect Network button of the Master Controller and it will look at all of the devices that are connected to it, determine which devices are its slaves, and refresh the Sub-Network frame in the lower left corner of your browser with all of the slaves detected.

Ethernet IP Address

When a controller is attached to a network, your IT Administrator needs to assign it an Ethernet IP address. When you want to communicate with the controller from your PC on the network, you go to your Browser and type in the controller’s address. Type that address into the text box.

Ethernet IP Netmask

When a controller is attached to a network, your IT Administrator must also assign the IP Netmask. Type the number assigned in the text box.

Ethernet Gateway

When a controller is attached to a network, your IT Administrator must also assign the Gateway. Type the number assigned in the text box.

Direct Serial Connection (RS232)**RS232 Serial IP Address**

In order to communicate with the controller via a laptop or nearby PC connected to the serial port on the front panel, you need to start your Browser software, and type in this address.

Direct Modem Connection (Point to Point)**Direct Modem IP Address**

This menu is information only and tells you the hard coded IP address for the controller when communicating to it via the direct modem to modem method.

ShoulderTAP[®] Internet Connection

Dialup Connection Status

This menu is informational only, and tells you what is happening with the dialup connection. Possible status messages include:

Message

- Off Line
- Dialing xxx-xxxx
- No Dial Tone
modem problems.
- No phone number
- Connecting to ISP

- On Line
- Checking for Upgrade
if a software upgrade is available.
- Connection Timeout in xxxxx sec
The number of seconds displayed

Explanation

The controller is not connected.
The controller is dialing out to the ISP.
The controller can not dial out due to phone line or

There is nothing entered in the ISP Phone No. field.
The controller is successfully negotiating a connection with the ISP.
The controller is now on the Internet.
The controller is communicating with our server to see

Once the Internet connection process is complete, depends upon the value entered in the Dialup Connection Lifetime text box described below.

Dialup Dynamic IP Address

This menu is informational only, and tells you the IP address of the last person to contact the controller.

Last Dialup Date and Time

This menu is informational only, and tells you when the controller was contacted last. Click on the “Submit” button to save the changes.

Dialup Connection Lifetime

This menu allows you to set a time limit on the Internet connection if no changes have been made. This will help control the cost of operating the controller if you forget to log off. Type in the text box the number of minutes that you want to pass by before disconnecting the Internet connection. Entering a connection lifetime of “0” means the connection will never timeout.

Manual Internet Dialup

Click on the Connect button to manually test the WebMaster’s ability to successfully dial out and connect with your ISP. This is convenient on installation, or to troubleshoot Internet connection problems. The Dialup Connection Status field will display what is happening as described above. Once you see that the Dialup Connection Status is “On-line”, you may disconnect the controller from the Internet by clicking the Disconnect button.

Modem Access Log

Click on the link to view the modem access log file. You will be prompted to either open the file (.csv format, normally opened in a spreadsheet) from its current location or to save the file to disk. Make your selection. The file will display the date and time of all modem connections, the type of connection (ShoulderTap or Direct Modem) if the attempt was a success or a failure, and if it failed, what the failure mode was.

5.12 Advanced Comms

Internet Dialup Account

Wait for dial tone before dialing

Click to place a check in the box if you want the modem to wait for a dial tone before calling out. In some countries the dial tone may not be recognized. If the modem will not recognize the dial tone, uncheck the box.

Modem Baud Rate

Click on the arrow of the pull-down to select different modem baud rates. The WebMaster modem is 38400. Normally there will be no reason to change the baud rate. The baud rate may be reduced if the controller is having problems at the higher speed due to poor phone line conditions. In the future, external modems may be supported that may not have the same baud rate.

ISP Authentication Method

Click on the arrow of the pull-down to select between Custom Script Authentication and ETS PAP Authentication. The custom scrip will work fine with many ISPs, however some ISPs require PAP protocol when the controller logs in. If this is the case, select ETS PAP.

Use ASMTTP for Email

Click to place a check in the box if your ISP requires authenticated simple mail transfer protocol for its email.

Common Network Settings

DNS IP Address

This text box contains the address of a valid Domain Name Server, which allows the WebMaster to send the emails using the name of the email server rather than the numeric SMTP IP address. This DNS IP address should never need to be changed, unless the server is experiencing problems.

Sub-Network Settings

Mapped Internet IP Address

If you are accessing the master controller by using NAT to translate a real IP address to a fake IP address, then type the real IP address into this field of the master controller.

Subnet Key

It is possible to convert a stand-alone unit to a Master by entering the correct subnet key. Please contact your distributor for details. You will need to purchase the key, enter it in this field, click the Submit button, and then cycle power to the unit. It will now be capable of being the Master in a network.

ShoulderTAP® Internet Connection

Dialup Connection Status

This menu is informational only, and tells you what is happening with the dialup connection. Possible status messages include:

Message

- Off Line
- Dialing xxx-xxxx
- No Dial Tone
modem problems.
- No phone number
- Connecting to ISP

- On Line
- Checking for Upgrade
if a software upgrade is available.
- Connection Timeout in xxxxx sec
The number of seconds displayed

Explanation

The controller is not connected.
The controller is dialing out to the ISP.
The controller can not dial out due to phone line or

There is nothing entered in the ISP Phone No. field.
The controller is successfully negotiating a connection with the ISP.
The controller is now on the Internet.
The controller is communicating with our server to see

Once the Internet connection process is complete, depends upon the value entered in the Dialup Connection Lifetime text box described below.

WaveComm Wireless Antenna Setup

Antenna Setup

Before attempting to run the antenna setup, make sure that the dialup status is “Off Line.” Click the Start Setup button. It will prompt you to verify that you really want to start the setup. Click Yes and the setup will begin. Click on End Setup when you have finished. The dialup status should return to “Off Line.”

Signal Strength

This field will display the actual modem response string from the wireless modem.

Suggestion

This field will tell you whether the signal strength is Good, or if its Bad and you should try to relocate the antenna.

5.13 Software Upgrade

(only appears if the WebAlert has an Internet connection and there is a more recent version of software available for download)

Whenever you connect to the WebAlert via an Internet connection, it will check to see if any software upgrades are available. If there are, then the Software Upgrade page link will appear. Note that this can only occur if the WebAlert is connected to the Internet, either through the modem or Ethernet.

If there is a newer version of software that you would like to load into your unit, then you can upgrade to the latest revision.

Click on the link “More Info on Software Upgrade” to see what features have been added.

Click on the link “Start Software Upgrade” in order to download the new version to the unit.

Note: Process monitoring is suspended during a software upgrade. If the unit being updated is a slave on a network of WebAlerts, both the master unit and the slave being updated will have process monitoring suspended during the upgrade process. Depending upon the extent of the changes and Internet traffic, the upgrade can take anywhere from 15 minutes to 2 hours to complete.

5.14 Configuration File

If many of your process monitoring applications are nearly identical, you can save a lot of time in the set up by downloading a typical configuration file to your hard drive, and later uploading the configuration file to another controller.

Export UCF

In order to transfer the User Configuration File (UCF) from the WebAlert to your computer, click the Export UCF link. You will be presented with the standard Windows dialog box to download a file. Click the radio button to Save this file to Disk, then click OK. Select the location where you want the file to be saved, change the name of the file if desired, then click Save. The file is only around 14KB, so it should be transferred relatively quickly. Click Close to close the dialog box.

The exact sequence of events and wording within the dialog box will vary depending upon the operating system (Windows 95, 98, NT, 2000, XP etc.) on your PC.

Browse

In order to transfer a previously saved UCF from your computer to this WebAlert, first click the Browse button to locate the file on your computer. A "Choose File" dialog box will open. Click on the correct file, then click Open.

Import UCF

Once the file name is displayed in the Browse text box, click the Import UCF button to transfer the file to the WebAlert.

5.15 Notepad

The configuration Notepad gives you a place to make notes regarding any changes that you have made to the set points, to document calibrations, system upsets or anything else that you want to note. Simply type your message into the text box.

5.16 Access Codes

There are three levels of access code protection. If the *Master* password is used in the WebAlert Authentication page, then any set point can be changed. If the *Calibration Level* password is used in the Authentication page, then sensor calibrations will be allowed, but other changes will not. If the *Read Only* password is used the user will be able to look at any page, but will not be allowed to make any changes.

In order to change the access code for each level of access, type the present password into the text box, then type the new password in the text box below. Type the new password again in the lowest text box to verify that the new password has been correctly entered.

The default user name is "webalert" and the default passwords are "2001" for full access, "2002" for calibration only and "2003" for read only. These defaults can and should be changed to assure security.

Change User Log-in Name

You may also change the user name for logging into the WebAlert. Type the new user name into the text box.

Download Access Log

Click the link to View Log File. The Modem Access Log will tell you when the WebAlert was accessed. It will show you the date and time of access, the method of access, the user name used, the IP address of the computer used for access, and the level of access code used (or that the attempt failed).

A window will open to ask if you would like to open the file or save it to disc. Select the method you would like to use. The file is a basic text file with a .log extension that may be opened in any word processing program (Word, Notepad, etc.).”

5.17 WebAlert Help

The Help link is active whenever the controller is on-line on the Internet. This will bring you to an on-line copy of the instruction manual and eventually to an on-line troubleshooting guide. Note that if you are communicating to the controller via any other method, where it is not on the Internet, the help link will not be functional.

5.18 Walchem Home Page

Click on this link to go directly to the Walchem web site, where you can find the latest instruction manuals, technical data sheets, email help, or to surf to another WebAlert.

5.19 Sub-Network

Once you have created a network of two or more WebAlert process monitors, purchased the Master Capability software for the master controller, defined the master unit as the master and slave units as slaves (see section 5.9) in the Communications page, and given each controller unique Ethernet IP addresses in the Communications page, the links under Sub-Network will be active.

To navigate between controllers on the sub-network, start by logging onto the master controller. This may be via RS232, Ethernet or modem. Once connected to the master, click on a link to the slave. The link will be given the custom name of the controller from the Startup page. The first time you connect to the slave in a given session, you will need to log on with that controller’s user name and password. After that, you will be able to bounce from one controller to another without logging on again.

If the links available do not accurately match the controllers on the network, go to the Communications page and click the “Detect Network” button. If the sub-network frame is still inaccurate, right click in the frame and click ‘Refresh.’ If still inaccurate, try rebooting the controller.

6.0 MAINTENANCE

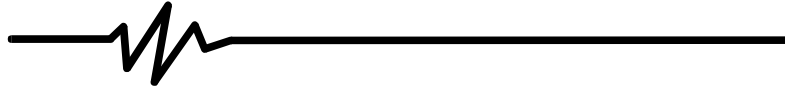

The WebAlert process monitor requires very little routine maintenance. The electronic enclosure only needs to be wiped down with a damp cloth to keep it clean.



CAUTION! The WebAlert inner hinged face panel is secured with Phillips (#1) screws, which require a tool to open. No user adjustments are inside. This panel should only be opened by trained maintenance personnel.

6.1 Replacing the Fuses

CAUTION: Disconnect power to the unit before opening the front panel!

Locate the fuses on the circuit board on the lower left side of the back of the controller enclosure. See figure 1, Identification of Parts. Gently remove the old fuse from its retaining clip. You can verify that the fuse has been blown by measuring continuity between the ends of the fuse using an ohmmeter. If it is blown, discard. Press the new fuse into the clip, secure the front panel of the controller, and return power to the unit.

Warning! Use of non-approved fuses can affect product safety approvals. Specifications are shown below. To ensure that UL/CSA product safety certifications are maintained, it is recommended that a Walchem fuse be used.

Fuse		Walchem Part Number			
F1	Protects input	103163	5 x 20 mm	1.0 amp	250V

7.0 TROUBLESHOOTING

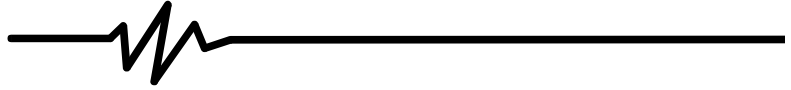

7.1 ERROR MESSAGES

“Generic 4-20 mA Input” High Alarm (one for each, use name defined)

This error message is caused by the 4-20 mA signal from a device other than a level transmitter, water meter, or corrosion monitor exceeding the user-programmed value for the high alarm limit.

Possible Causes

The process value being measured by the is out of specifications

The high alarm limit for the process being measured is set too low.

There is a problem with the transmitter that needs to be addressed by the manufacturer of the transmitter.

Corrective Actions

Determine the reason for the out of spec transmitter condition.

Increase the high limit in the Other 4-20 mA Input Page.

“Generic 4-20 mA Input” Low Alarm (one for each, use name defined)

This error message is caused by the 4-20 mA signal from a device other than a level transmitter, water meter, or corrosion monitor being lower than the user-programmed value for the low alarm limit.

Possible Causes

The process value being measured by the is out of specifications.

The low alarm limit for the process being measured is set too high.

There is a problem with the transmitter that needs to be addressed by the manufacturer of the transmitter.

Corrective Actions

Determine the reason for the out of spec transmitter condition.

Decrease the low limit in the Other 4-20 mA Input Page.

4-20 mA Input Sensor Error

This error message is caused by a 4-20 mA input signal that is less than 3.9 mA or greater than 21 mA.

Possible Causes

Faulty transmitter.

Faulty wiring between transmitter and analog input.

Faulty analog input option circuit board.

Corrective Actions

Make sure that the transmitter is functioning by measuring the output using an ammeter. If the output directly from the transmitter is less than 4 mA, the transmitter is the problem.

Repeat the measurement of the transmitter output at the 4-20 mA input option board terminal strip. If this is less than 4 mA, then the wiring is faulty. Also make sure that the wires are attached to the correct terminals as defined in the 4-20 mA Input Page.

Replace the 4-20 mA input option board.

Drum Level Low Alarm (one for each used)

This error message appears if either a level switch or level transmitter is putting out a signal that indicates a low level of solution. This could mean that the level switch is either open or closed, or that the level transmitter is indicating a volume below the user-programmed low alarm limit.

Possible Causes

Low chemical level.

Level switch float is stuck.

Faulty level switch.

Incorrect setting of the low alarm limit.

Faulty level switch or transmitter wiring.

Incorrect setting of “Drum low when switch is open/closed” menu.

Corrective Actions

Replenish chemical supply.

Clean level switch.

Remove level switch from drum and verify that the switch opens and closes as the float is moved up and down.

Go to the appropriate Input Page and make sure that the Low Alarm Limit is set to the correct value.

Correct wiring. Make sure that the level sensor is attached to the same input as the one which is defined for that drum in the Input Page.

Go to the Digital Input Page and verify that the “Drum low when switch is” menu is set for the proper selection. You can check the operation of the switch by measuring between the two wires with an ohmmeter. If there is continuity between the wires when the float is all the way down, then select “closed”.

Incorrect setting of the “Empty mA” menu.

Go to the 4-20 mA Input Page and make sure that the Empty mA setting matches the actual mA of the transmitter when the tank is empty.

Faulty digital input.

If the switch is functioning, and it is wired correctly, and the settings are correct, replace the board.

Faulty 4-20 mA input.

If the level transmitter is putting out a mA signal above the low alarm limit (as measured by an ammeter) and is wired correctly, replace the board.

Digital Input High Rate

Digital Input Low Rate

Digital Input Total Limit

Modem Failure

This error message is caused by a failure of the controller to recognize that the option circuit board is connected.

Possible Causes

Poor connection of the option board to the core board.

Faulty modem board.

Corrective Actions

Remove the option board and inspect both mating connectors for corrosion or damage. Reinstall the option board.

Replace the board.

Ethernet Failure

This error message is caused by a failure of the controller to communicate with the Ethernet chip.

Possible Causes

Poor connection of the option board to the core board.

Faulty Ethernet board.

Corrective Actions

Remove the option board and inspect both mating connectors for corrosion or damage. Reinstall the option board.

Replace the board.

8.0 SERVICE POLICY

The WebAlert Series process monitors have a 2-year warranty on electronic components and a 1-year warranty on mechanical parts.

We stock replacement parts for immediate exchange after we have isolated the cause of a problem.

Factory authorized repairs that are received via next-day-air will be returned within 24 hours. Normal turnaround time for returns is two weeks.

Out of warranty repairs are done on a flat fee basis.